

## QTH-NKS-11 High Pin Count QTH Module

### 4- Channel 12-bit ADC 210MSPS

### 4- Channel 16-bit DAC 1GSPS

#### Description

The QTH-NKS-11 is a 4-channel 12-bit ADC at 210MSPS and 4-channel 16-bit DAC at 1GSPS that enable simultaneous and high speed sensitivity. This module was designed based on dual-channel ADS62P28 ADC of TI Company with CMOS or DDR LVDS outputs and dual-channel DAC5682 DAC of TI Company with DDR LVDS inputs. The clock sampling can be provided from an external or internal source and then send to distribution clock unit. This module can use on every carrier card which follows the QSH/QTH standard; therefore it can have the maximum data throughput and minimum latency.

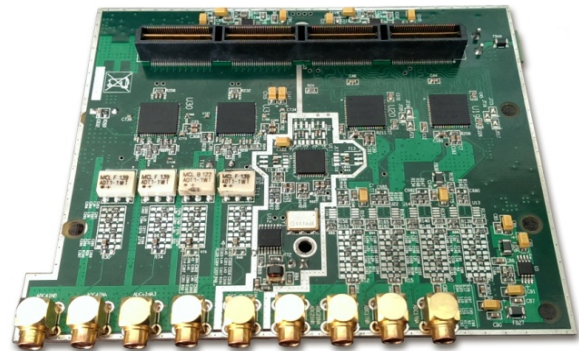

#### Functional Block Diagram

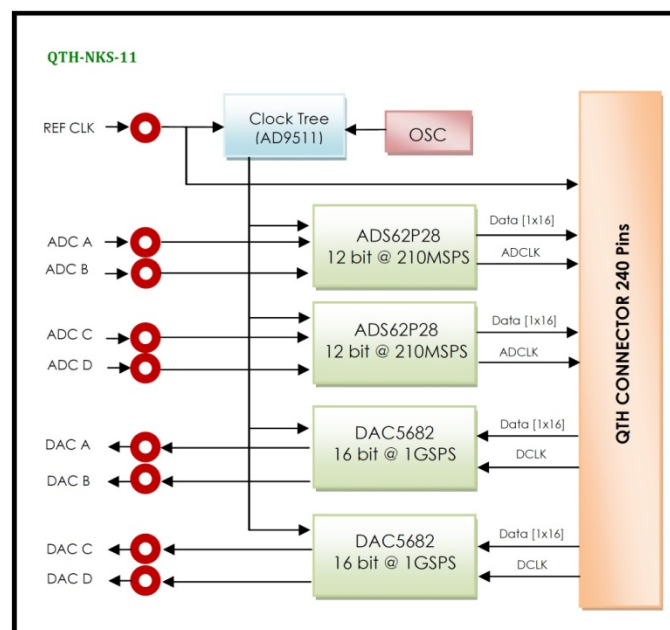

## Features

### ADC's:

- 4 Channels, 12-bit Resolution, 210 MSPS ADC Converters
- SNR = 73 dBFS @ 70 MHz and 210 MSPS
- SFDR = 86 dBc @ 70 MHz and 210 MSPS
- ENOB = 11.6 Bits @ 70 MHz and 210 MSPS
- Analog Input Filter Options
- Efficient DDR LVDS-Compatible Outputs
- Analog Input: 2V p-p Range
- Xtalk Isolation >91 dB
- Differential Input with 450 MHz Bandwidth
- QTH Interface Connector for Digital Input Output, Power LEDs and Single-ended MCX Connector for AIN, AOUT& EXTCLK
- Direct ADC/DAC Connection to Host FPGA Ensures
- Maximum Throughput
- Physical Dimensions (L: 113 mm, W: 92.2 mm)
- Industrial Temperature Range (-40°C to 85°C)

### DAC's:

- 4 Channels, 16-Bit Resolution, 1GSPS Update Rate
- Analog Output with 500MHz Bandwidth
- Analog Output Filter Options
- Phase Noise > 100dBc @ 1kHz and 1GSPS
- Interleaved I/Q data for Dual-DAC Mode
- 2x-32x Clock Multiplying PLL/VCO
- 2x or 4x Interpolation Filters
- Differential Scalable Output: 2 to 20 mA
- Compatible with DAC 5681

### Other's:

- Serial Port Control: Programmable Clock and Data Alignment
- On-board Clock Distributer

## Application

- RADAR/SONAR
- Medical Equipments
- GPS
- Wide Band-Width Communications

## Board Features

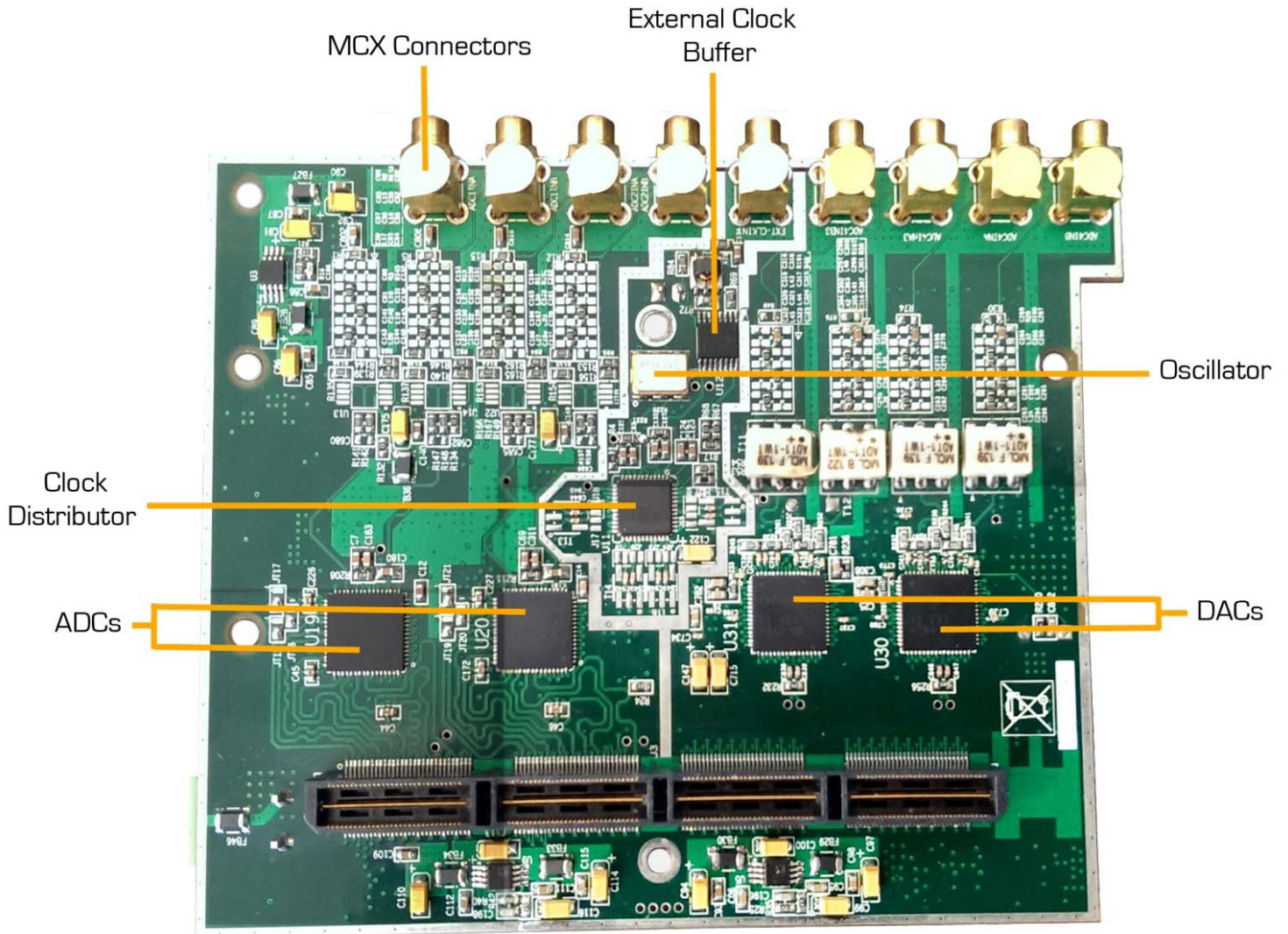

## Compatibility Table

NIKSOO Platform	Compatibility
SP-V4SX55-PCI-A	Yes
NKS-V5-PCIE-A-SX50T	Yes
NKS-V5-PCIE-A-SX95T	Yes
FP-NKS-01-A	Yes
NKS-V5-PCI-A	Yes
FMC-NKS106-PCI-A	Yes
FMC-NKS016-PCIE-A	Yes

## Order Information

