

NKS-V5-PCI-A High Pin Count QSH Carrier Virtex-5 Processing PCI Card

Description

The NKS-V5-PCI-A is a QSH industrial carrier card based on the Xilinx Virtex-5 LX155T FPGA family and supports 32-bit or 64-bit PCI bus data paths, Ethernet10/100 and Ethernet10/100/1000. This board also provides a developed platform for designing and verifying Virtex-5 FPGA based PCI and Stand-Alone applications. SATA II interface is suitable for high performance digital IF sampling. Communication with a host computer via the PCI bus and other interfaces enables users to control the card, modify algorithm settings and process real-time signals. Additionally, this card can transfer high bandwidth data through QSH/QTH standard modules.

Features

- Virtex XC5VLX155T-2FFG1136I Xilinx Device
- 64-bit 66MHz/32-bit 33MHz PCI Add-in Card Connector.
- Enhanced 10/100 Ethernet Full Stack Interface with RJ-45 Connector
- Ethernet PHY 10/100/1000 Interface with RJ-45 Connector
- 1 Gb SDRAM Component Memory
- QSH Connector for ADC/DAC QTH Modules Connect to FPGA
- Spartan XC3S50AN for PCI-based
- 128 Mb Platform Flash XL & 256 Mb Linear BPI Flash
- Multi-boot Configuration, or Download Using Xilinx Platform Cable USB
- User Push-button, Switches, LEDs and General Purpose I/O Header
- JTAG and Trace Debug Ports
- PCI Clocking Support for Global and Regional Cloning Applications
- Four On-board Clock Sources
- SPI EEPROM (4Mb)
- 2x RS422/485
- 1 Serial ATA Disk Drive Interface Connector
- 5V PCI & External Voltage Supply
- Physical Dimensions (L: 230.6 mm, W: 120.9 mm)
- Industrial Temperature Range (-40°C to 85°C)
- Operation System Support: Windows & Linux

Functional Block Diagram

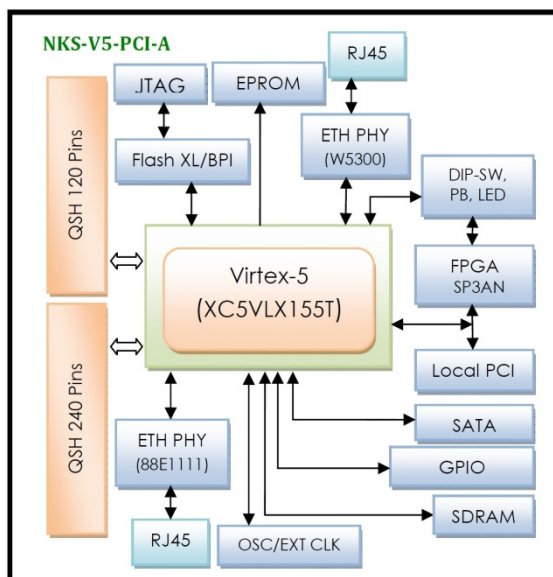

Application

- RADAR
- Communications
- Smart Antenna Systems
- General-purpose Software Radio
- Ultrasound Equipment

WWW.NIKSOO.COM/NKS-V5-PCI-A

Board Features

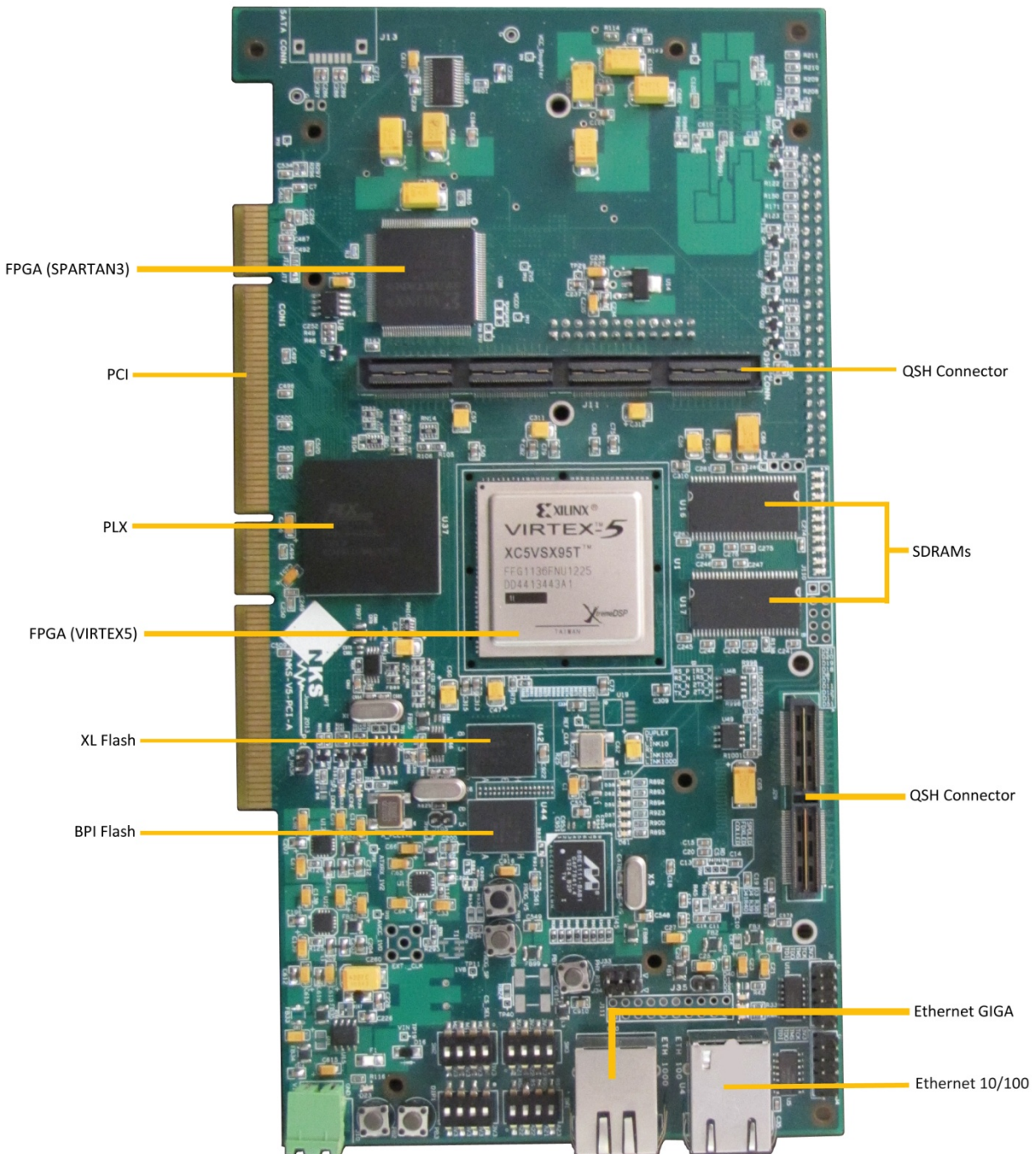

Compatibility Table

NIKSOO Platform	Compatibility
QTH-NKS-01	Yes
QTH-NKS-02	Yes
QTH-NKS-02-A	Yes
QTH-NKS-03	Yes
QTH-NKS-07	Yes
QTH-NKS-10	Yes
QTH-NKS-11	Yes
QTH-NKS-12	Yes
QTH-NKS-11-A	Yes

Order Information

