

FMC-NKS-401210 High Pin Count FMC Module

4- Channel 16-bit ADC 125MSPS

2- Channel 16-bit DAC 1GSPS

Description

The FMC-NKS-401210 is a four-channel 16-bit ADC at 125MSPS synchronous and maximum sampling rate and dual channel 16-bit DAC at 1GSPS synchronous and maximum sampling rate. This module was designed based on dual-channel AD9268 ADC of Analog Device Company with DDR LVDS or CMOS outputs and dual-channel DAC5682 DAC of TI Company with DDR LVDS inputs. Because of containing a FMC-HPC connector, FMC-NKS-401210 is mechanically and electrically compliant to VITA 57.1 standard. Controlling of clock source, sampling frequency and calibration by a SPI BUS are its other features. The sample clock can be supplied from PLL clock generator, externally through a coax connection or supplied by an internal clock source (VCO). This module can use on every carrier card which follows the VITA 57.1 standards; therefore it can have the maximum data throughput and minimum latency.



Functional Block Diagram

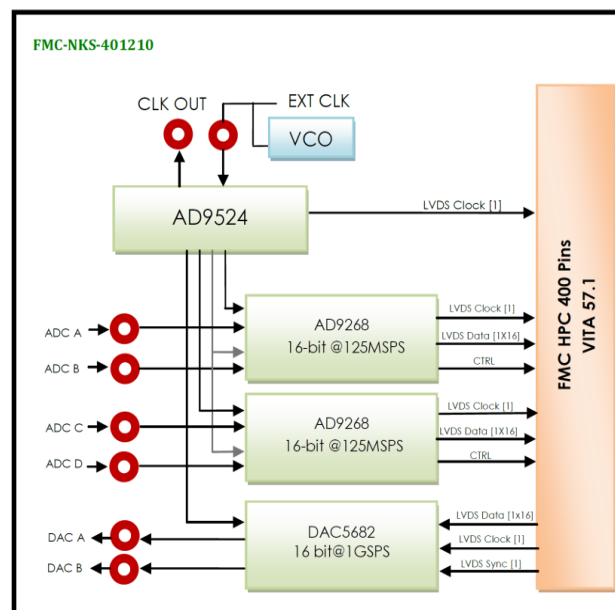

WWW.NIKSOO.COM/FMC-NKS-401210

Support: support@niksoo.com www.niksoo.com

Email: info@niksoo.com

Features

ADC's:

- 4 Channels, 16-bit Resolution, 125 MSPS
- Differential Analog Input with 650MHz Bandwidth
- 1.8V CMOS or LVDS Output Signal
- SNR > 75 dBFS @ 20 MHz and 125 MSPS
- SFDR > 85 dBc @ 20 MHz and 125 MSPS
- ENOB > 12.5 Bits @ 20 MHz and 125 MSPS
- Flexible Analog Input Range: 1V p-p to 2V p-p
- Xtalk Isolation > 95dB
- High Performance AC-Coupled Analog Input
- Serial Port Control
- Low Power: 750 mW @ 125 MSPS
- Pin Compatible with AD9258, AD9251, AD9231 and AD9204.

DAC's:

- 2 Channels, 16-Bit, 1GSPS Update Rate
- 16-Bit Input LVDS Data Bus
- Analog Output with 500MHz Bandwidth
- Phase Noise > 100dBc @ 1kHz and 1GSPS
- Serial Port Control
- 2x-32x Clock Multiplying PLL/VCO
- 2x or 4x Interpolation Filters
- High Performance AC-Coupled Analog Output
- Compatible with DAC5681

Other:

- VITA 57.1 Compliant
- FMC Interface Connector for Digital Output, Power LEDs and Single-ended SMC or other Connectors for AIN, AOUT& EXTCLK
- Flexible clock tree enables Internal (VCO) and External Clock
- Direct ADC/DAC Connection to Host FPGA Ensures
- Operating temperature: -40°C to +85°C (Industrial)
- Physical Dimensions (L: 83.8 mm, W: 69 mm)

Application

- Radar/SONAR
- Wide Band-Width Communications
- Ultrasound Equipments
- Software Defined Radio (SDR)
- Medical Equipment
- Advanced control systems and Remote forwarding

Support

- NIKSOO Platforms Reference Design Available
- User Manual
- Reference Firmware Design (VHDL)
- Reference ISE Project for Virtex-6 and Kintex-7

Board Features

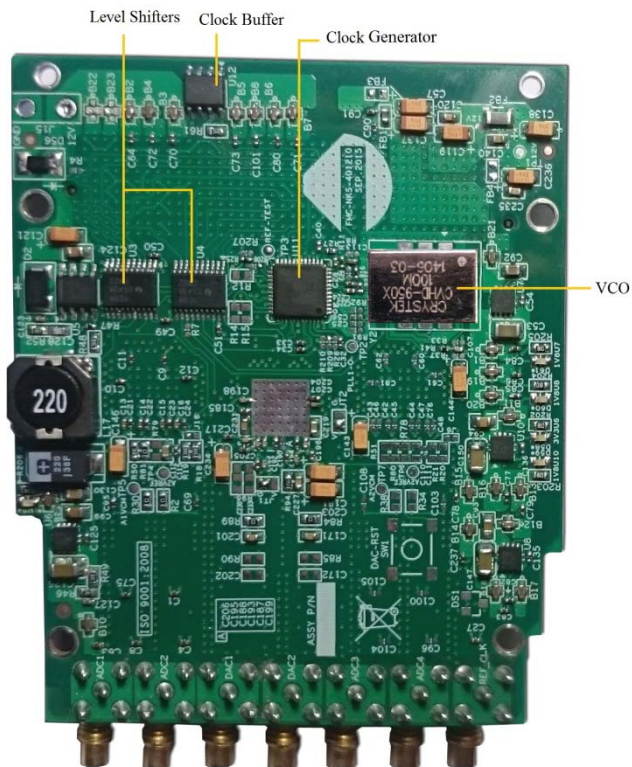
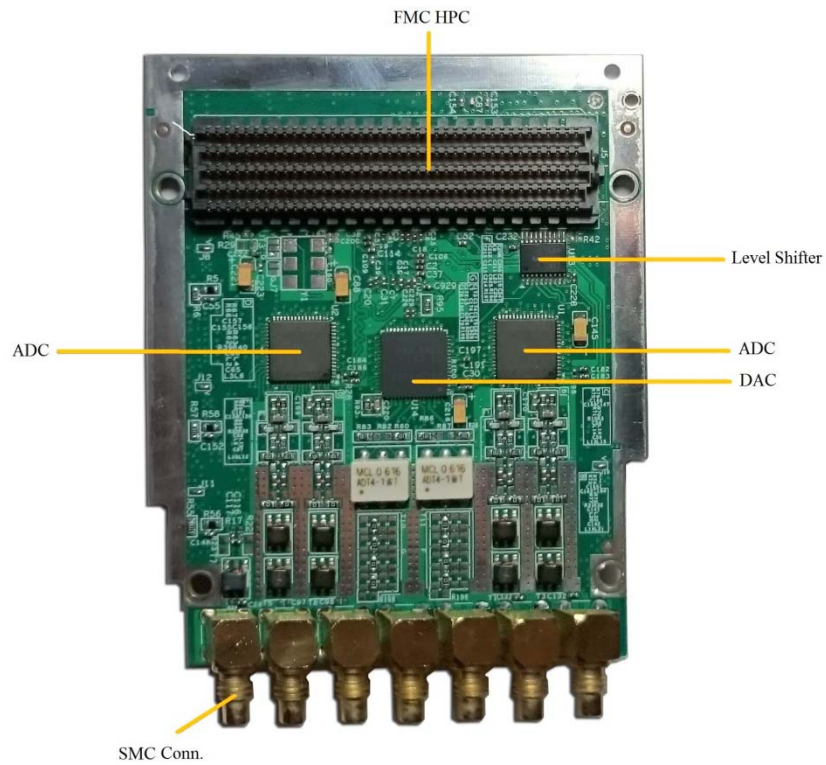

Compatibility Table

Platform	Compatibility
FMC-NKS016-PCIE-A	Yes
FMC-NKS106-PCI-A	Yes
FMC-NKS-V106-A	Yes
FMC-NKS016-PCIE-B	Yes
FMC-NKS-K017-PCIE-A	Yes

Order Information

