

## FMC-NKS-V106- A High Pin Count FMC and QSH Carrier Virtex-6 Processing Card

### Description

The FMC-NKS-V106-A is a high performance FMC industrial carrier card based on the Xilinx Virtex-6 LX365T FPGA family. Communication with host computers on this board via two Ethernet 10/100/1000 enables users to control the card, modify algorithm settings and process real-time signals. The on-board FPGA Mezzanine Connectors (FMC) can make a high-bandwidth data transfer channel with VITA 57.1 standard modules. There is also 2x 4-bank QSH and 2x 2-bank QSH connector on this platform.

### Features

- 2x Virtex XC6VLX365T-2FFG1156C Xilinx Device
- 2x QSH Connector (80 GPIO) for SRAM Module
- High Speed Serial Connection (GTP) Between Two FPGA
- FMC HPC for ADC/DAC FMC Modules
- SRAM Module: 32Mb-100MH
- 2x Ethernet PHY 10/100/1000 Interface with RJ-45 Connector
- USB 2.0
- 20x RS485 and 4x RS232 Module
- 32 bit Buffered GPIO (TTL/CMOS)
- 40 Pair High Speed LVDS
- Other Input/output GPIO
- Multi-boot Configuration
- Power on/off Slide Switch
- 12V External Voltage Supply
- Physical Dimensions (L: 300 mm, W: 160 mm)
- Industrial Temperature Range (0°C to 85°C)
- Operation System Support: Windows & Linux

### Functional Block Diagram

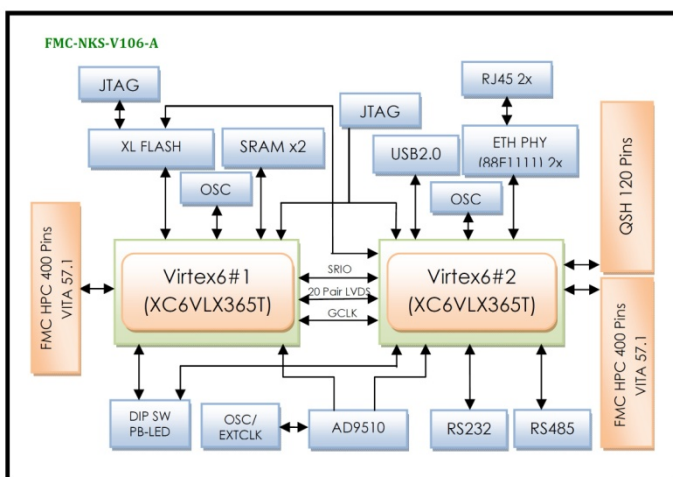

### Application

- RADAR
- Communications
- Multimode Digital Receivers (3G)
- GSM, EDGE, W-CDMA, LTE
- CDMA2000, WiMAX, TD-SCDMA
- Smart Antenna Systems
- General-purpose Software Radios
- Broadband Communications Transmissions

## Board Features

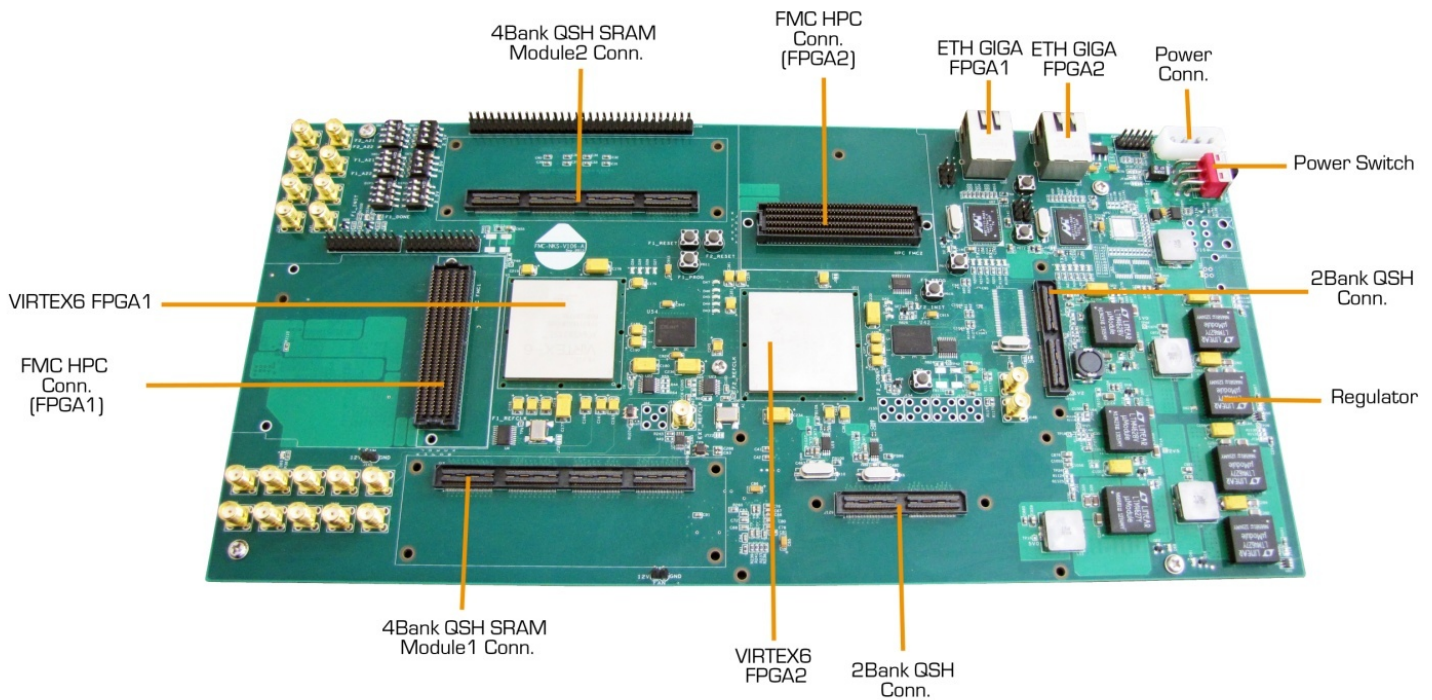

## Compatibility Table

NIKSOO Platform	Compatibility
FMC-NKS-210000	Yes
FMC-NKS-210210	Yes
FMC-NKS-402410	Yes
FMC-NKS-401000	Yes
FMC-NKS-000210	Yes
FMC-NKS-110110	Yes
FMC-NKS-601000	Yes
FMC-NKS-401110	Yes

## Order Information

