

## FMC-NKS-601000 High Pin Count FMC Module 2- Channel 16-bit ADC 65MSPS

### Description

The FMC-NKS-601000 is a 2-channel 16-bit ADC which can provide synchronous and maximum sampling rate at 65MSPS. This module was designed based on dual-channel AD9650 ADC of Analog Device Company with DDR LVDS or CMOS outputs. Because of containing a FMC-HPC connector, FMC-NKS-601000 is mechanically and electrically compliant to VITA 57.1 standard. Controlling of clock source, sampling frequency and calibration by a SPI BUS are its other features. The clock sampling can be provided from an external or internal source and then send to distribution clock unit. This module can use on every carrier card which follows the VITA 57.1 standards; therefore it can have the maximum data throughput and minimum latency.

### Functional Block Diagram

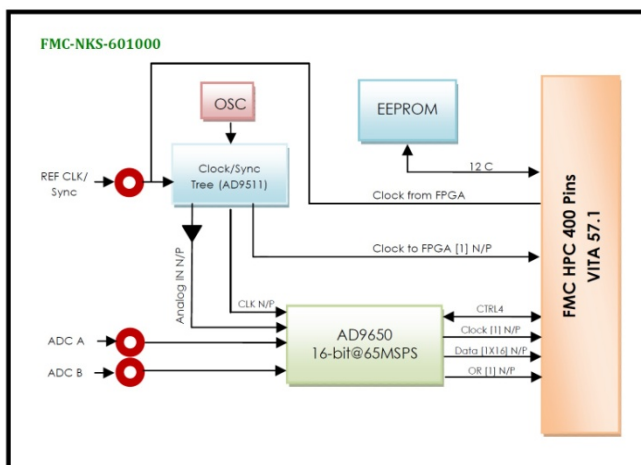

### Features

#### ADC's:

- 2 Channels, 16-Bit Resolution, 65 MSPS
- SNR = 80 dBFS @ 70 MHz and 65 MSPS
- SFDR = 87 dBc @ 70 MHz and 65 MSPS
- ENOB = 12.8 Bits @ 70 MHz and 65 MSPS
- Differential Analog Inputs with 500 MHz Bandwidth
- Low Power: 328 mW @ 25 MSPS
- High Performance DC-Coupled Analog Input
- 1.8 V Analog Supply Operation
- 1.8 V CMOS or LVDS Output Supply
- Analog Input Range of 2.7 V p-p
- Pin Compatible with AD9268, AD9269, AD9251, AD9231 and AD9204.

#### Other's:

- VITA 57.1 Compliant
- FMC Interface Connector for Digital Output, Power LEDs and Single-ended MCX Connector for AIN & EXTCLK
- Flexible Clock Tree Enables (Internal Clock, External Clock)
- Direct ADC Connection to Host FPGA Ensures
- Maximum Throughput
- Operating Temperature: -40°C to +85°C (Industrial)
- Physical Dimensions (L: 83.8 mm, W: 69 mm)

### Application

- RADAR/SONAR
- Industrial instrumentation
- Smart antenna systems
- Multimode digital receivers (3G)
- WiMAX 802.16
- GPS

[WWW.NIKSOO.COM/FMC-NKS-601000](http://WWW.NIKSOO.COM/FMC-NKS-601000)

Support: [support@niksoo.com](mailto:support@niksoo.com)  
Email: [info@niksoo.com](mailto:info@niksoo.com)

## Board Features

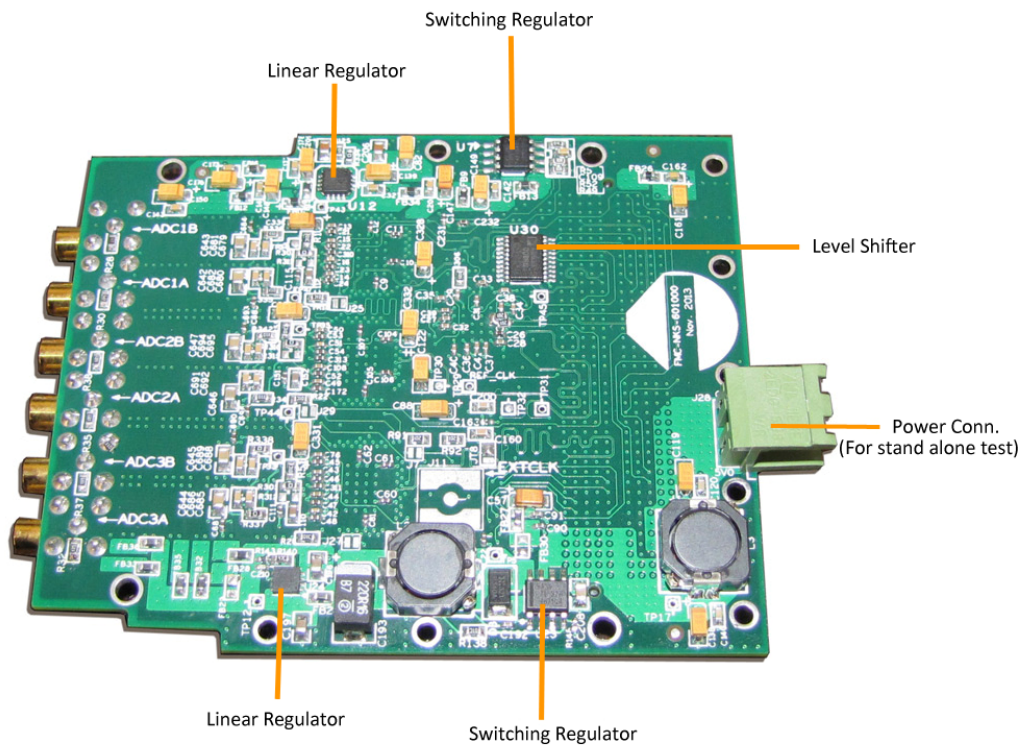
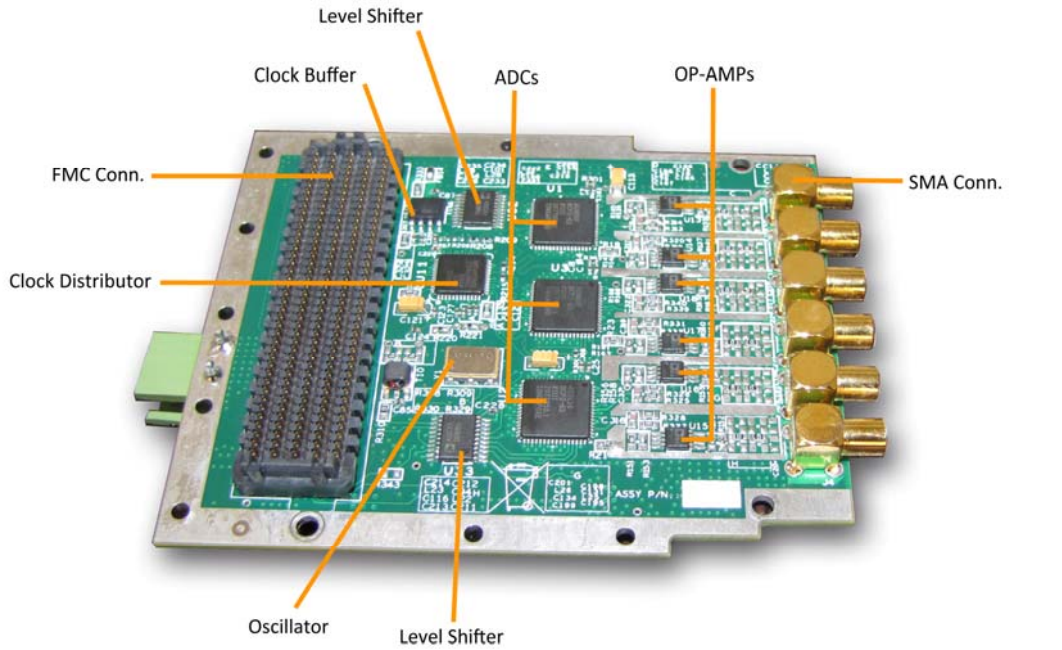

## Compatibility Table

Platform	Compatibility
FMC-NKS016-PCIE-A	Yes
FMC-NKS106-PCI-A	Yes
FMC-NKS-V106-A	Yes
VITA57.1 Carrier Cards	Yes

## Order Information

