

## NKS-V5-PCIe-A High Pin Count QSH Carrier Virtex-5 Processing PCIe Card

### Description

The NKS-V5-PCIe-A is a QSH industrial carrier card based on the Xilinx Virtex-5 LX85T FPGA family and plugged into a serial PCIe bus system unit supporting 1x, 4x and 8x PCIe data paths. This board also provides a developed platform for designing and verifying Virtex-5 FPGA based PCIe and Stand-Alone applications. SATA II interface is suitable for high performance digital IF sampling. Communication with a host computer via the PCIe bus and other interfaces enables users to control the card, modify algorithm settings and process real-time signals. Additionally, this card can transfer high bandwidth data through QSH/QTH standard modules.

### Features

- Virtex XC5VLX85T-3FFG1136C Xilinx Device
- PCI Express x8 Edge Connector
- Enhanced 10/100 Ethernet Full Stack Interface with RJ-45 Magnetics Connector
- 1 Gb SDRAM Component Memory (up to 167MHz)
- QSH Connector for ADC/DAC QTH Modules Connect to FPGA
- Xilinx LOGICORE™ IP Supported PCI Express Endpoint Designs in X1, X4, and X8 Configurations
- Device Configuration Through On-board Platform Flash (8 MB)
- Download Using Xilinx Platform Cable USB (JTAG Programming Interface)
- 1 Serial ATA Disk Drive Interface Connector
- Enhanced High Speed USB 2.0 Interface
- User Push-button, Switches, 16xLEDs, 20xGPIO Header, JTAG and Trace Debug Ports
- Clocking (PCIe, SATA, and Two On-board Clock Sources)
- 12V PCIe HDD Connector or External Voltage Supply
- Physical Dimensions (L: 220.2 mm, W: 120.7 mm)
- Industrial Temperature Range (0°C to 85°C)
- Operation System Support: Windows & Linux

### Functional Block Diagram

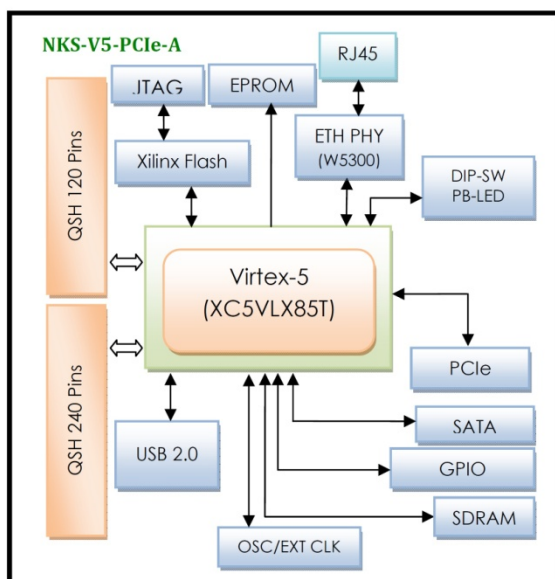

### Application

- RADAR
- Parallel Processing Applications
- High-Bandwidth Data Transfer
- High Performance Data Acquisition
- Communications

## Board Features

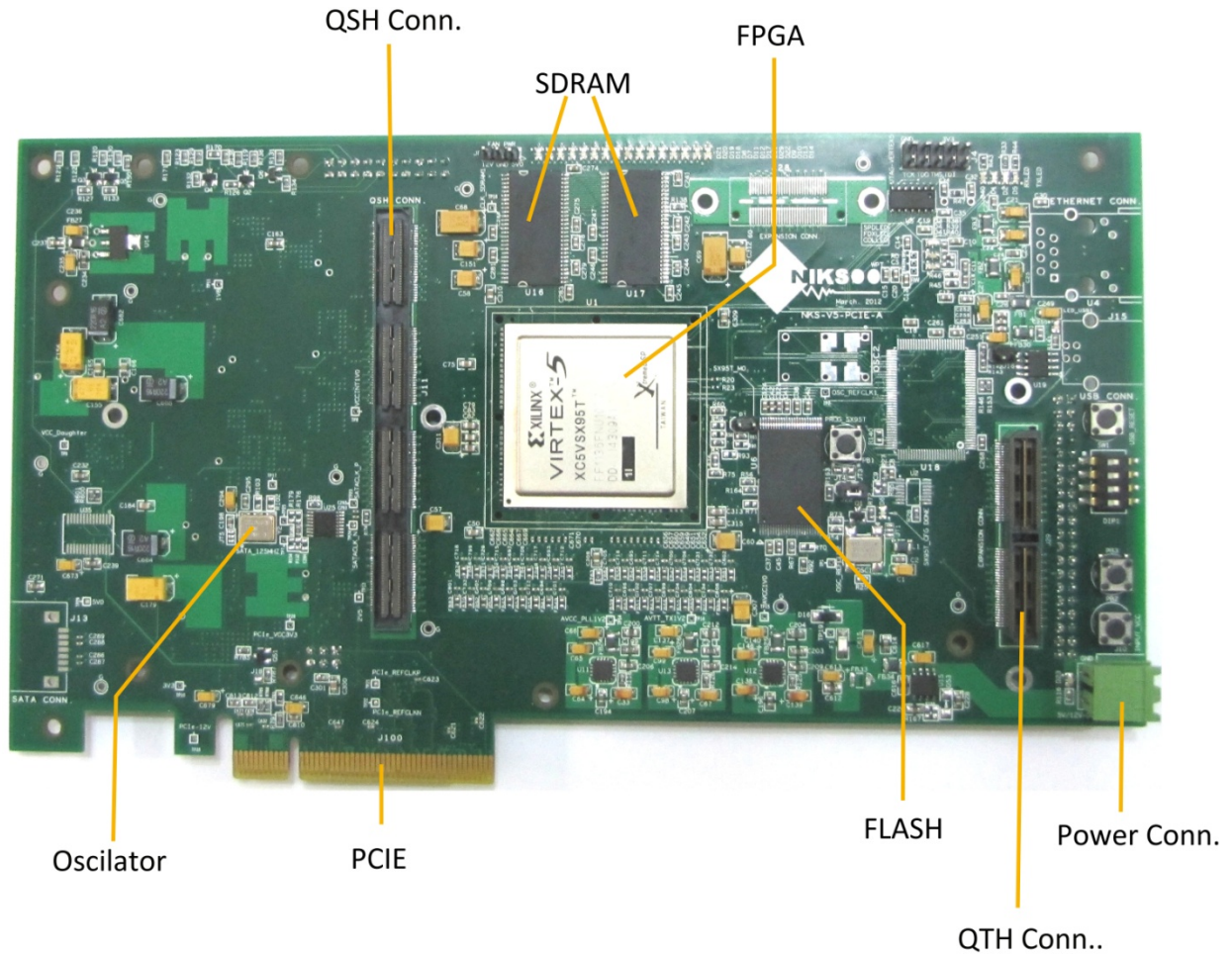

## Compatibility Table

NIKSOO Platform	Compatibility
QTH-NKS-01	Yes
QTH-NKS-02	Yes
QTH-NKS-02-A	Yes
QTH-NKS-03	Yes
QTH-NKS-07	Yes
QTH-NKS-10	Yes
QTH-NKS-11	Yes
QTH-NKS-12	Yes
QTH-NKS-11-A	Yes



# NKS-V5-PCIe-A

---