

QTH-NKS-02-A High Pin Count QTH Module

1- Channel 16-bit ADC 200MSPS

Description

The QTH-NKS-02-A is a 1-channel 16-bit ADC at 200MSPS that enable simultaneous and high speed sensitivity. This module was designed based on one channel ADS5485 ADC of TI Company with DDR LVDS outputs. The clock sampling can be provided from an external or internal source and then send to distribution clock unit. This module can use on every carrier card which follows the QSH/QTH standard; therefore it can have the maximum data throughput and minimum latency.

Features

- 1 Channels, 16-bit Resolution 200 MSPS
- SNR = 74 dBFS @ 10 MHz and 200 MSPS
- SFDR = 88 dBc @ 10 MHz and 200 MSPS
- ENOB = 12.1 Bits @ 10 MHz and 200 MSPS
- Analog Input Filter Options
- Efficient DDR LVDS-Compatible Outputs
- Flexible Analog Input: 1V p-p to 3V p-p Range
- Serial Port Control: Programmable Clock and Data Alignment
- 3.3V and 5V Analog Supply Operation
- Xtalk Isolation >100 dB
- High Performance AC-Coupled and DC-Coupled Analog Input
- On-board a Clock Distributer
- Differential Input with 730 MHz Bandwidth
- On-board 1000MHZ Ultra Low Phase Noise Crystal Oscillator
- QTH Interface Connector for Digital Output, Power LEDs and Single-ended MCX Connector for AIN & EXTCLK
- Direct ADC Connection to Host FPGA Ensures
- Maximum Throughput
- Physical Dimensions (L: 107.7 mm, W: 92.2 mm)
- Pin Compatible with ADS5483/5482/5481, ADCs
- Industrial Temperature Range (-40°C to 85°C)

Functional Block Diagram

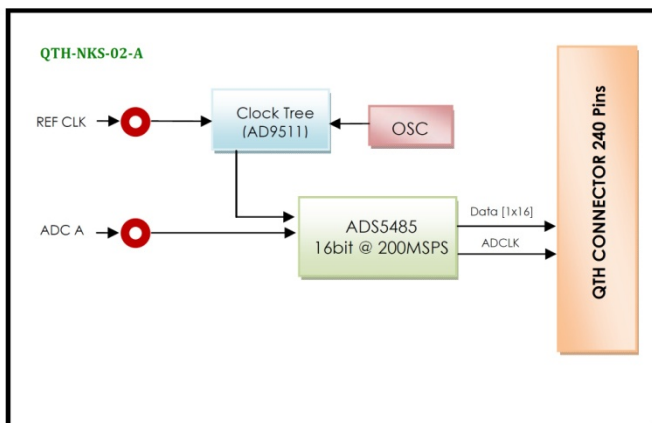

Application

- RADAR
- Medical Instruments
- Data Acquisition
- Test Measurement Instrumentation
- GPS

Board Features

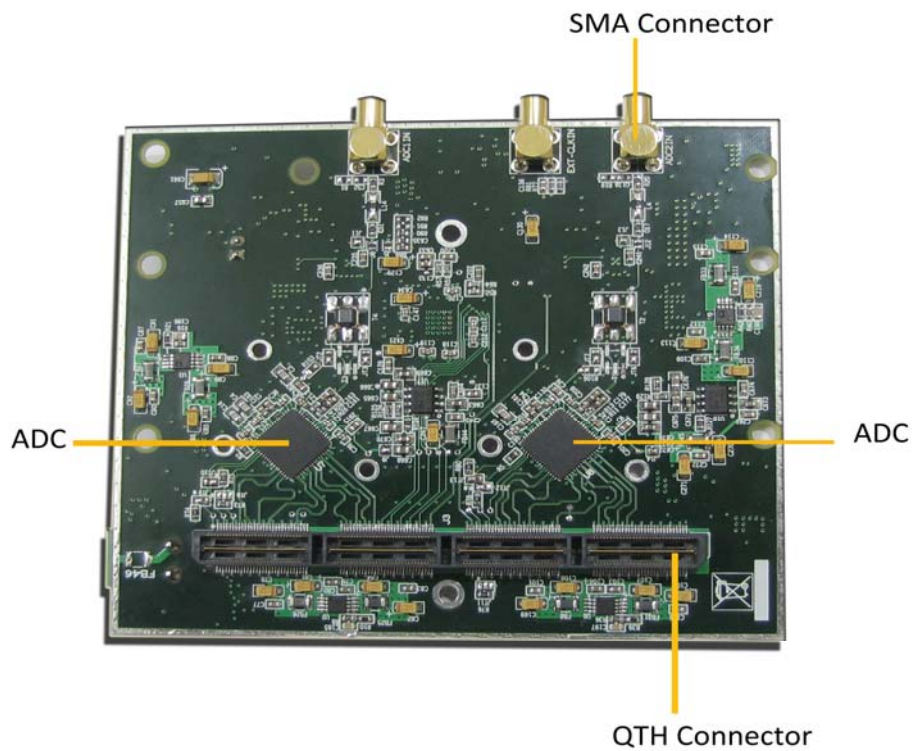
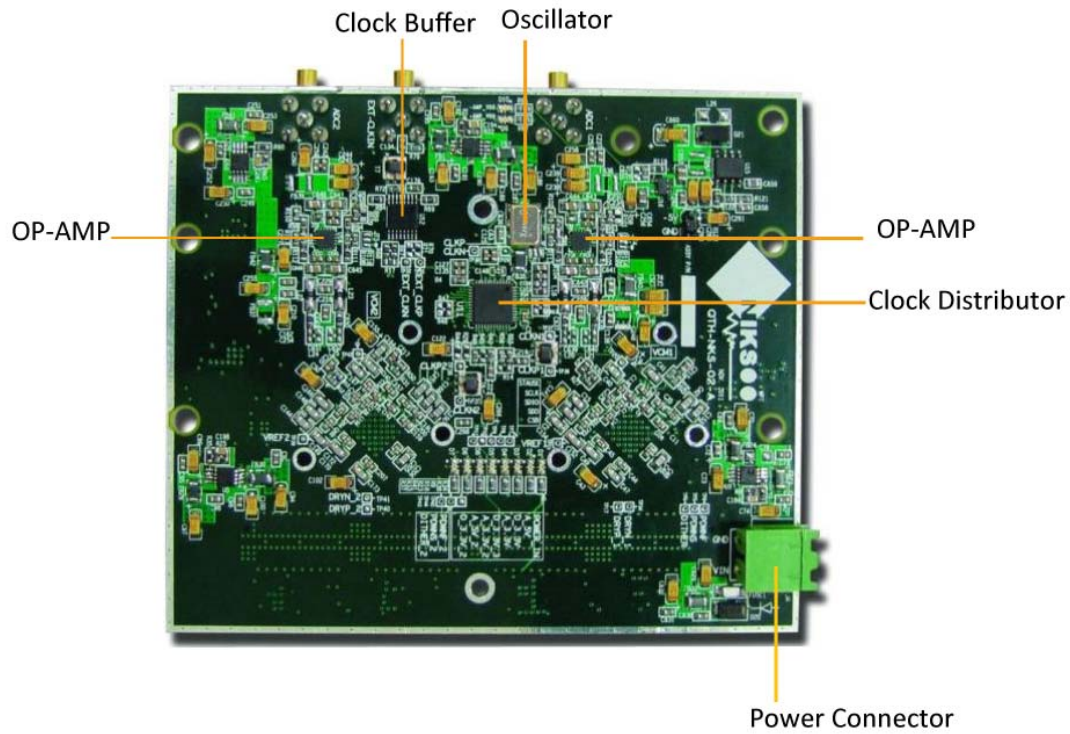

Compatibility Table

NIKSOO Platform	Compatibility
NKS-V5-PCIE-A	Yes
FP-NKS-01-A	Yes
NKS-V5-PCI-A	Yes
FMC-NKS106-PCI-A	Yes
FMC-NKS016-PCIE-A	Yes

Order Information

