

## FMC-NKS -K017-PCIe-A High Pin Count FMC Carrier Kintex-7 Processing PCIe Card

### Description

The FMC-NKS-K017-PCIe-A board is a high performance FMC industrial carrier card based on the Xilinx Kintex-7 FPGA family and plugged into a serial PCIe bus system unit supporting 1x and 4x PCIe data paths, Ethernet10/100/1000 and SATA. This board also provides a developed platform for designing and verifying Kintex-7 FPGA based PCIe and stand-alone applications. Communication with a host computer via the PCIe bus and other interfaces enables users to control the card, modify algorithm settings and process real-time signals. The on-board FPGA Mezzanine Connectors (FMC) can make a high bandwidth data transfer channel with VITA 57.1 standard modules.

### Features

- Kintex XC7K325T-2FFG676C Xilinx Device Compatible with 70T, 160T and 410T Kintex-7 Family
- Spartan-3 XC3S700AN
- 3x SATA ii, iii
- PCI Express x4 Edge Connector
- FMC HPC for ADC/DAC FMC Modules Connect to FPGA
- QTH Connector Connect to FPGA Spartan-3
- 8Gb DDR3 Component Memory
- Ethernet PHY 10/100/1000 Interface with RJ-45 Connector
- USB JTAG Module
- User Push-button, Switches, LEDs
- Multi-boot Configuration
- Power on/off Slide Switch
- 12V PCIe HDD Connector or External Voltage Supply
- Physical Dimensions (L: 185 mm, W: 135 mm)
- Industrial Temperature Range (0°C to 85°C)
- Operation System Support: Windows & Linux

### Functional Block Diagram

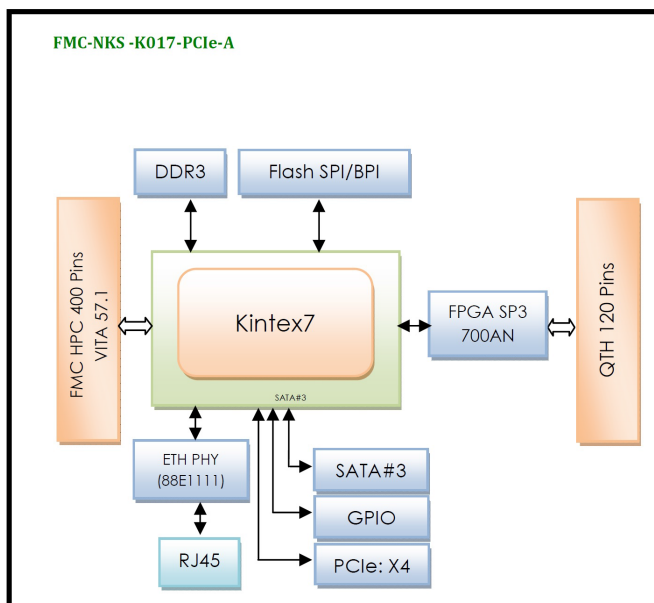

### Application

- RADAR/SONAR
- Communications
- Multimode Digital Receivers
- Ultrasound Equipment
- Broadband data Applications

## Board Features

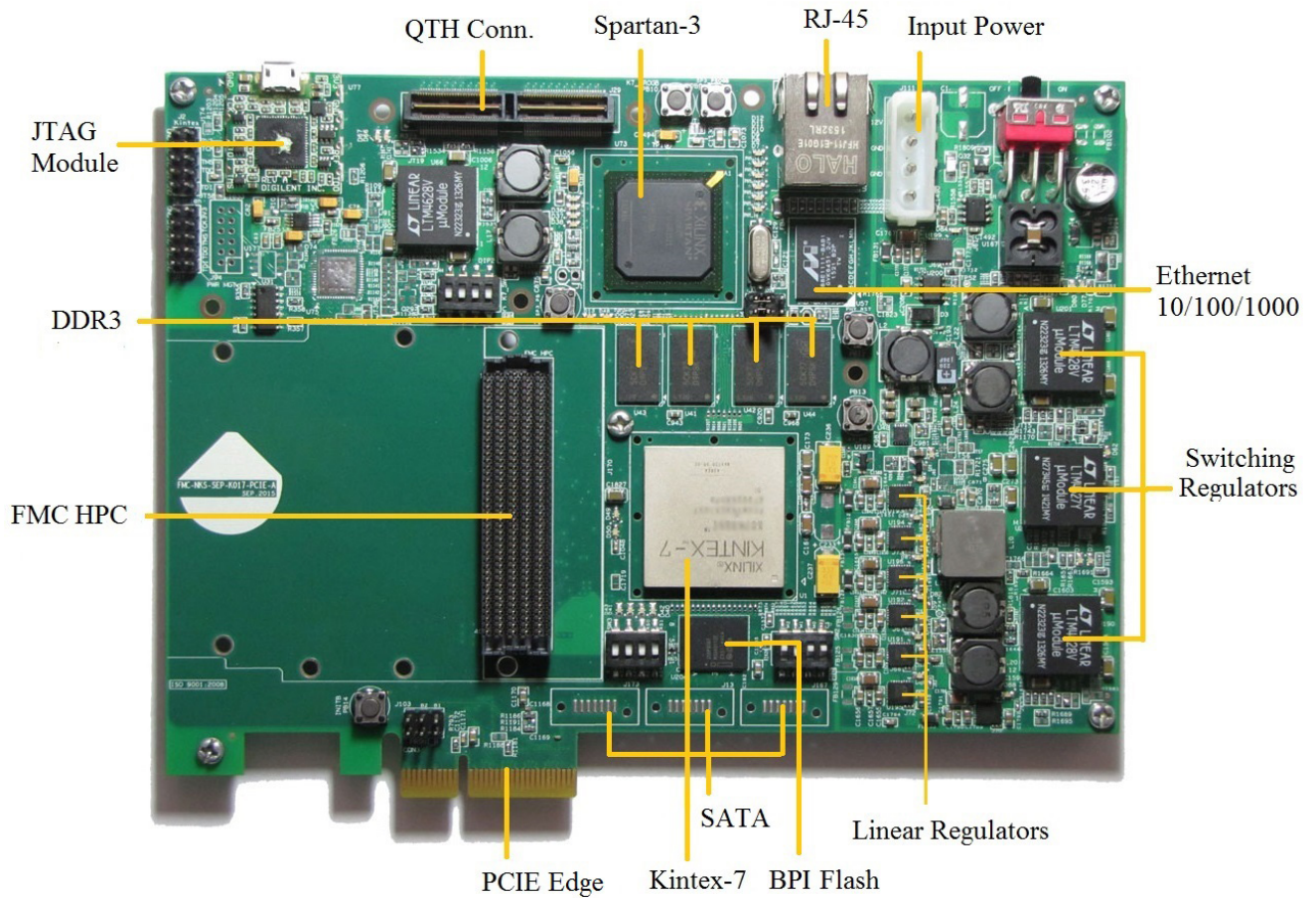

## Compatibility Table\*

NIKSOO Platform	Compatibility
FMC-NKS-210000	Yes
FMC-NKS-210210	Yes
FMC-NKS-402410	Yes
FMC-NKS-401000	Yes
FMC-NKS-000210	Yes
FMC-NKS-110110	Yes
FMC-NKS-601000	Yes
FMC-NKS-401110	Yes
FMC-NKS-401210	Yes

\* Compatible with any Module Follows VITA 57.1 Standard