

QTH-NKS-10 High Pin Count QTH Module

6- Channel 12-bit ADC 250MSPS

2- Channel 12-bit DAC 1GSPS

Description

The QTH-NKS-10 is a 6-channel 12-bit ADC at 250MSPS and dual-channel 12-bit DAC at 1GSPS that enable simultaneous and high speed sensitivity. This module was designed based on dual-channel ADS62P29 ADC of TI Company with CMOS or DDR LVDS outputs and dual-channel AD9776 DAC of Analog Device Company with CMOS inputs. The clock sampling can be provided from an external or internal source and then send to distribution clock unit. This module can use on every carrier card which follows the QSH/QTH standard; therefore it can have the maximum data throughput and minimum latency.

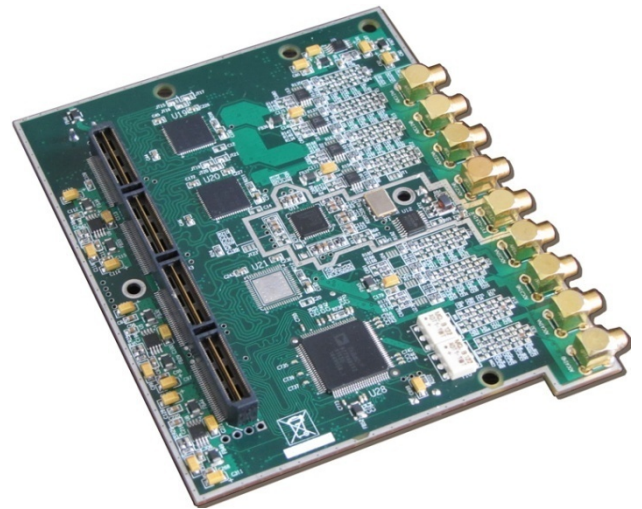

Functional Block Diagram

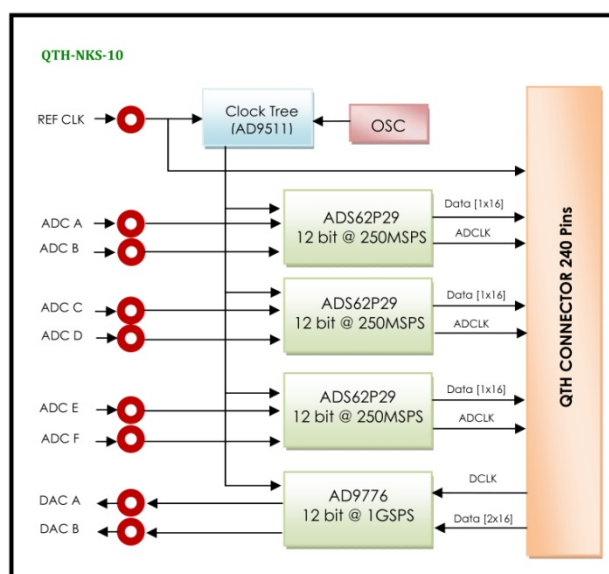

WWW.NIKSOO.COM/QTH-NKS-10

Support: support@niksoo.com
Email: info@niksoo.com

www.niksoo.com

Features

ADC's:

- 6 Channels, 12-bit Resolution, 250 MSPS
- SNR = 73 dBFS @ 70 MHz and 250 MSPS
- SFDR = 86 dBc @ 70 MHz and 250 MSPS
- ENOB = 11.6 Bits @ 70 MHz and 250 MSPS
- Analog Input Filter Options
- Efficient DDR LVDS-Compatible Outputs
- Analog Input: 2V p-p Range
- Xtalk Isolation >91 dB
- Differential Input with 450 MHz Bandwidth
- QTH Interface Connector for Digital Input Output, Power LEDs and Single-ended MCX Connector for AIN, AOUT& EXTCLK
- Direct ADC/DAC Connection to Host FPGA Ensures
- Maximum Throughput
- Physical Dimensions (L: 113 mm, W: 92.2 mm)
- Industrial Temperature Range (-40°C to 85°C)

DAC's:

- 2 channels, 12-bit Resolution, 1GSPS DAC Converters
- Analog Output Filter Options
- Interleaved I/Q data for Dual-DAC Mode
- Analog Output: 1V p-p Range
- 3.3V Analog Supply Operation
- 2x, 4x and 8x Interpolation Filters
- Maximum Differential Output with 500 MHz Bandwidth
- High Performance AC-Coupled Analog Output
- SFDR = 80dBFS

Other's:

- Serial Port Control: Programmable Clock and Data Alignment
- On-board Clock Distributer

Application

- RADAR/SONAR
- Medical Equipments
- GPS
- Wide Band-Width Communications

Board Features

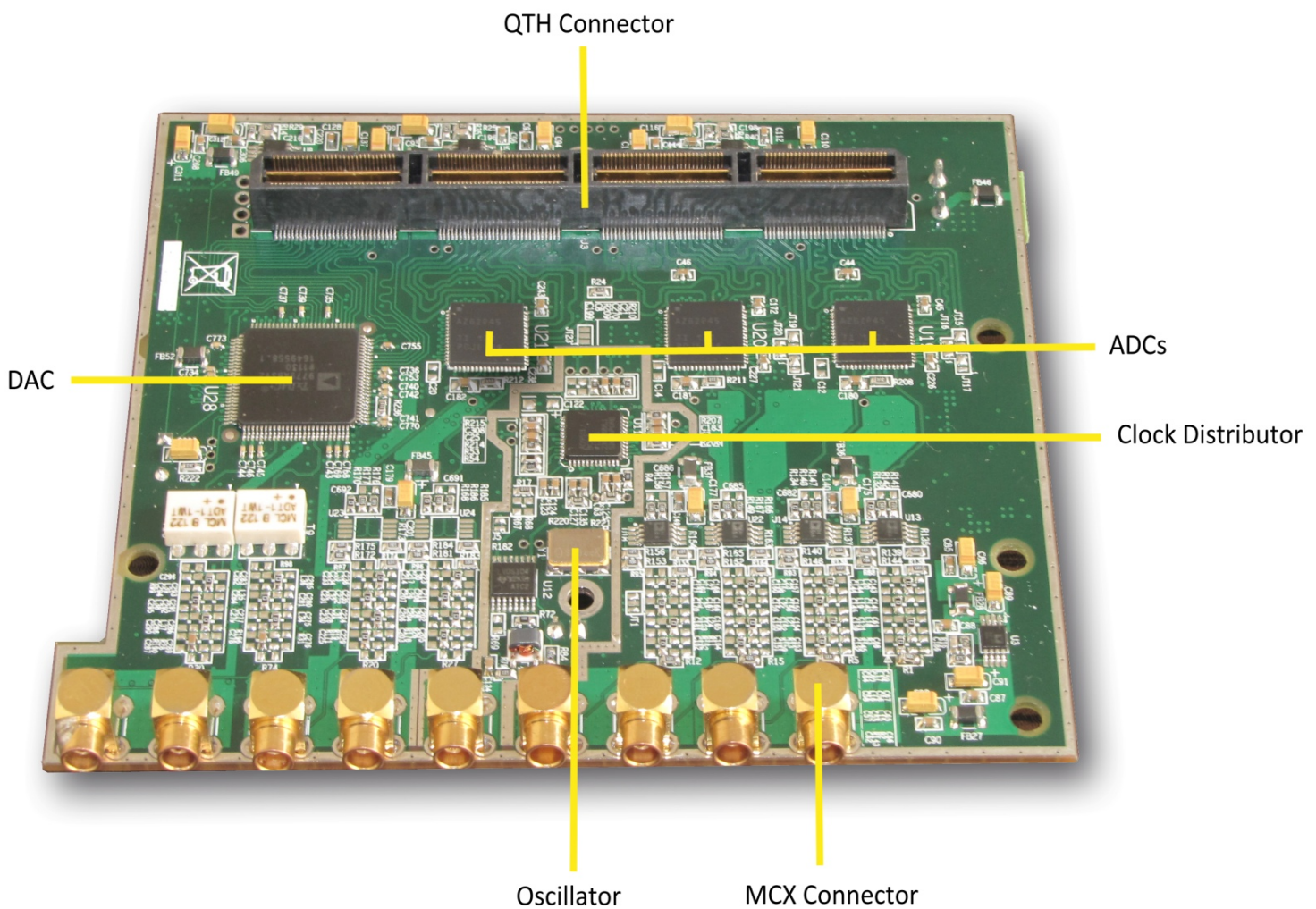

Compatibility Table

NIKSOO Platform	Compatibility
NKS-V5-PCIE-A	Yes
FP-NKS-01-A	Yes
NKS-V5-PCI-A	Yes
FMC-NKS106-PCI-A	Yes
FMC-NKS016-PCIE-A	Yes

Order Information

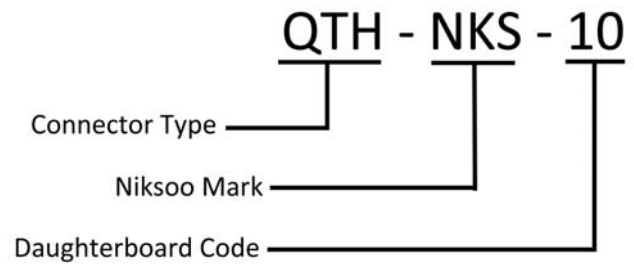



QTH-NKS-10
