

## FMC-NKS-401000 High Pin Count FMC Module 2-Channel 16-bit ADC 80MSPS

### Description

The FMC-NKS-401000 is a 2-channel 16-bit ADC which can provide synchronous and maximum sampling rate at 80MSPS. This module was designed based on dual-channel AD9650 ADC of Analog Device Company with DDR LVDS or CMOS outputs. Because of containing a FMC-HPC connector, FMC-NKS-401000 is mechanically and electrically compliant to VITA 57.1 standard. Controlling of clock source, sampling frequency and calibration by a SPI BUS are its other features. The clock sampling can be provided from an external or internal source and then send to distribution clock unit. Additionally a trigger input for customized sampling control is available. This module can use on every carrier card which follows the VITA 57.1 standards; therefore it can have the maximum data throughput and minimum latency.

### Features

#### ADC's:

- 2 Channels, 16-bit Resolution, 80 MSPS
- Differential Analog Input with 650MHz Bandwidth
- Analog Input Filter Options
- SNR = 75 dBFS @ 70 MHz and 80 MSPS
- SFDR = 86 dBc @ 70 MHz and 80 MSPS
- ENOB = 12.5 Bits @ 70 MHz and 80 MSPS
- Xtalk Isolation > 95dB
- Low Power: 750 mW @ 80 MSPS
- High Performance AC-Coupled Analog Input
- 1.8 V Analog Supply Operation
- 1.8 V CMOS or LVDS Output Supply
- Flexible Analog Input Range: 1V p-p to 2V p-p
- Serial Port Control
- Pin Compatible with AD9258, AD9251, AD9231, AD9268 and AD9204.

#### Other's:

- VITA 57.1 Compliant
- FMC Interface Connector for Digital Output, Power LEDs and Single-Ended MCX Connector for AIN, AOUT & EXTCLK
- Flexible Clock Tree Enables (Internal Clock, External Clock, Internal Clock with External Reference)
- Direct ADC Connection to Host FPGA Ensures
- Operating Temperature: -40°C to +85°C (Industrial)
- Physical Dimensions (L: 83.8 mm, W: 69 mm)

### Functional Block Diagram

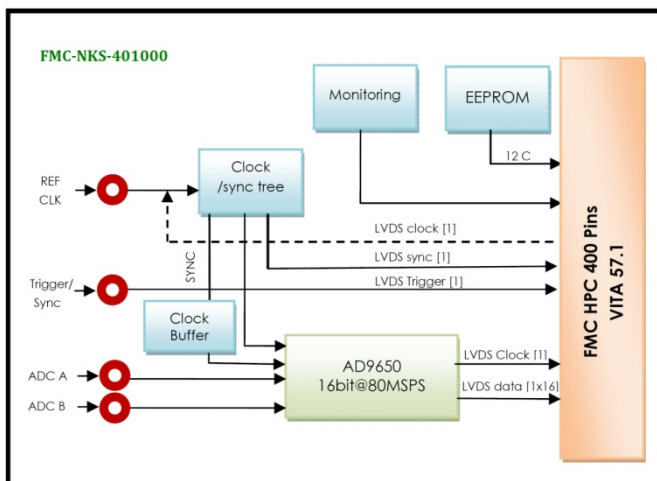

### Application

- RADAR/SONAR
- Medical Equipment
- Multimode digital receivers (3G)
- GSM, EDGE, W-CDMA, LTE
- CDMA2000, WiMAX, TD-SCDMA

## Board Features

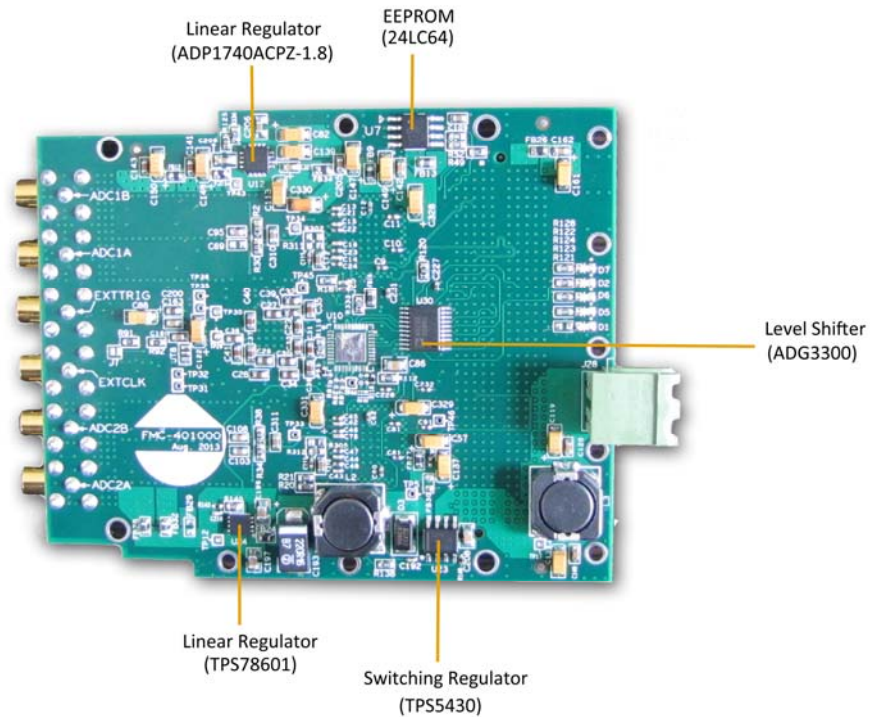
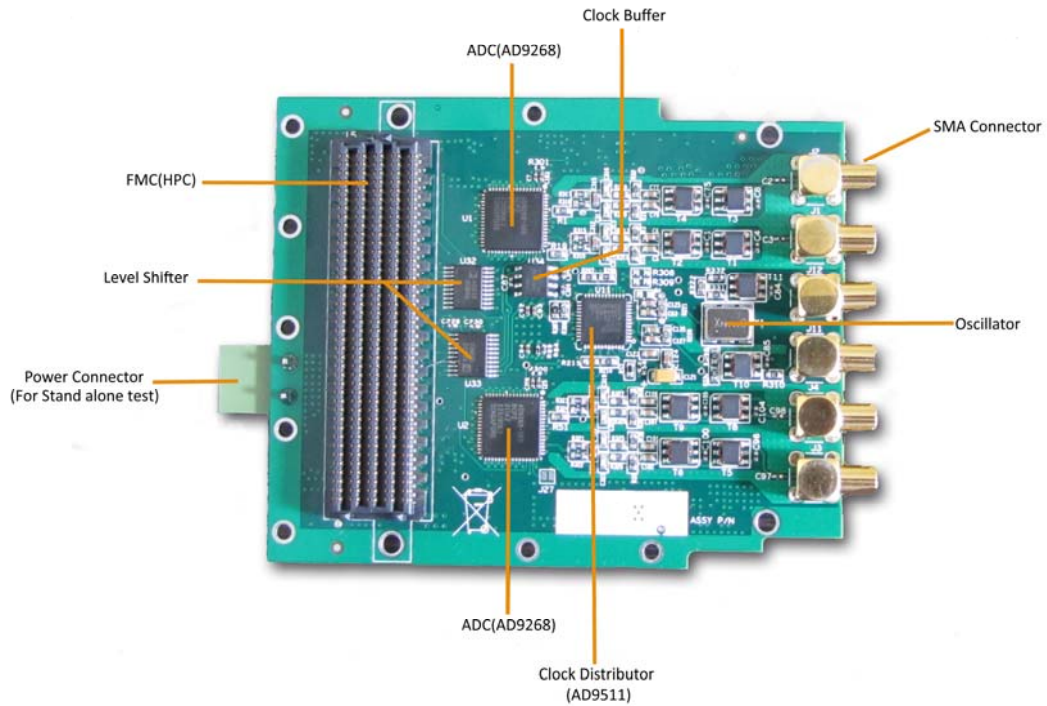

## Compatibility Table

Platform	Compatibility
FMC-NKS016-PCIE-A	Yes
FMC-NKS106-PCI-A	Yes
FMC-NKS-V106-A	Yes
VITA57.1 Carrier Cards	Yes

## Order Information

