

FMC-NKS106-PCI-A High Pin Count FMC and QSH Carrier Virtex-6 Processing PCI Card

Description

The FMC-NKS106-PCI-A board is a high performance FMC industrial carrier card based on the Xilinx Virtex-6 LX365T FPGA family and supports 32-bit or 64-bit PCI bus data paths and Ethernet10/100/1000. This board also provides a developed platform for designing and verifying Virtex-6 FPGA based PCI and stand-alone applications. Communication with a host computer via the PCI bus and other interfaces enables users to control the card, modify algorithm settings and process real-time signals. The on-board FPGA Mezzanine Connectors (FMC) and QSH can make a high bandwidth data transfer channel with VITA 57.1 and QSH/QTH standard modules.

Features

- 2x Virtex XC6VLX365T-1FFG1156C Xilinx Device
- High Speed Serial Connection (GTP) Between Two FPGA
- 64-bit 66MHz/32-bit 33MHz PCI Add-in Card Connector
- Spartan XC3S700AN for PCI-based and User I/O
- FMC HPC for ADC/DAC FMC Modules
- QSH Connector for ADC/DAC QTH Modules Connect to FPGA
- Ethernet PHY 10/100/1000 Interface with RJ-45 Connector
- 20 bit Buffered GPIO Connect to Main FPGA (TTL/CMOS)
- 28 input/output GPIO Connect to Auxiliary FPGA
- 2x RS485 and 2x RS232 Interface
- Header 2*40P 180D(F) for Connecting to DSP Module
- DDR3-SDRAM (High Speed, CMOS Dynamic Random Access Memory)
- Multi-boot Configuration
- User Push-button, Switches, LEDs
- Power on/off Slide Switch
- 12V External Voltage Supply
- Physical Dimensions (L: 295 mm, W: 135 mm)
- Industrial Temperature Range (0°C to 85°C)
- Operation System Support: Windows & Linux

Functional Block Diagram

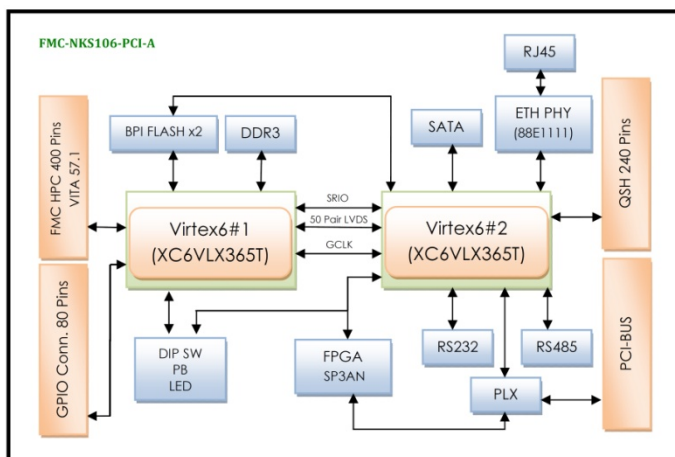

Application

- RADAR/SONAR
- Communications
- Multimode Digital Receivers
- Ultrasound Equipment
- Broadband data Applications

Board Features

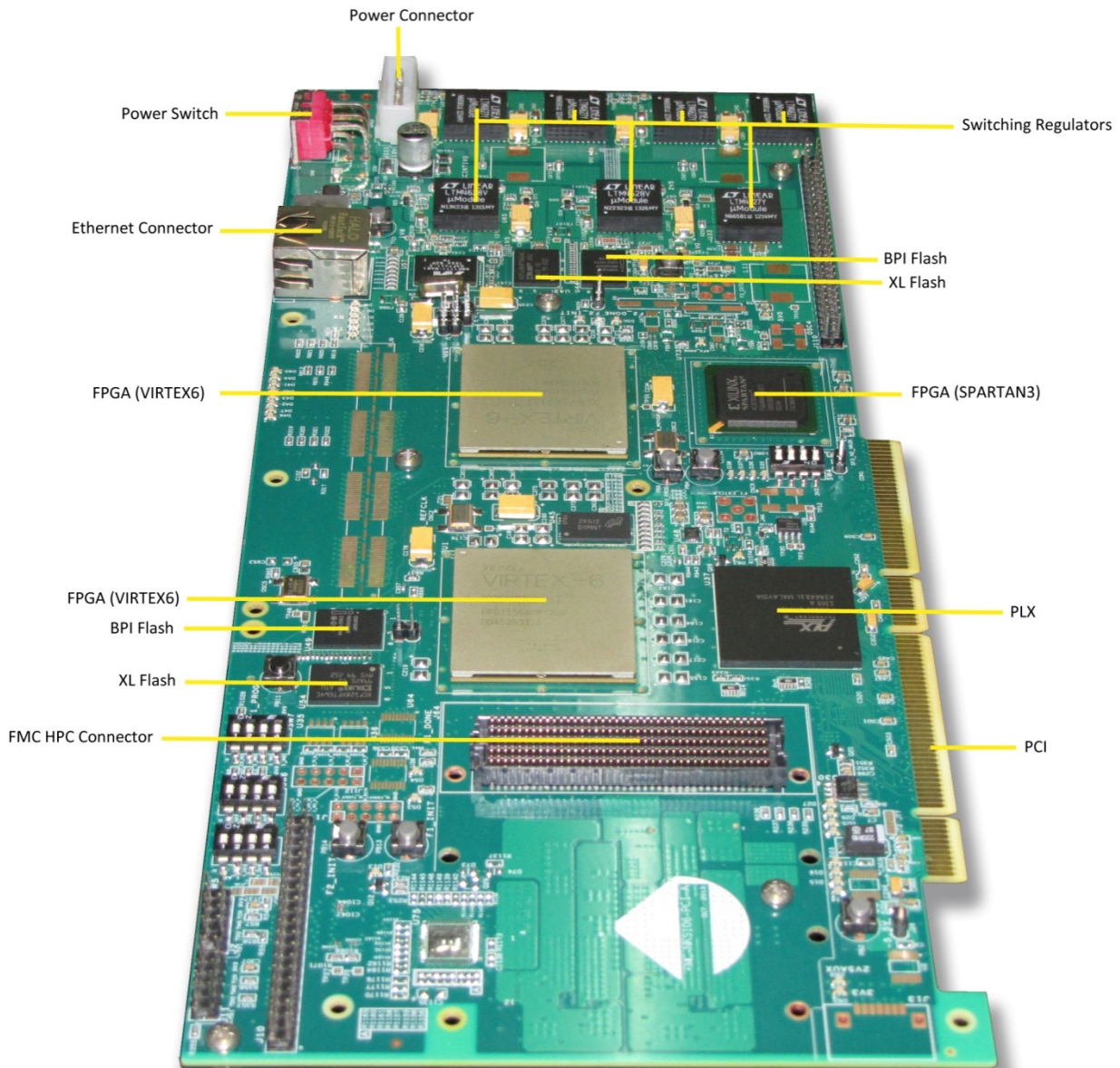

Compatibility Table

NIKSOO Platform	Compatibility
QTH-NKS-01	Yes
QTH-NKS-02	Yes
QTH-NKS-02-A	Yes
QTH-NKS-03	Yes
QTH-NKS-07	Yes
QTH-NKS-10	Yes
QTH-NKS-11	Yes
QTH-NKS-12	Yes
QTH-NKS-11-A	Yes
FMC-NKS-210000	Yes
FMC-NKS-210210	Yes
FMC-NKS-402410	Yes
FMC-NKS-401000	Yes
FMC-NKS-000210	Yes
FMC-NKS-110110	Yes
FMC-NKS-601000	Yes
FMC-NKS-401110	Yes

Order Information

