

FMC-NKS-401110 High Pin Count FMC Module

2-Channel 16-bit ADC 105MSPS 1-Channel 18-bit DUC 1GSPS

Description

The FMC-NKS-401110 is a 2-channel 16-bit ADC at 105MSPS synchronous and maximum sampling rate and single channel 18-bit DUC at 1GSPS synchronous and maximum sampling rate. This module was designed based on dual-channel AD9268 ADC of Analog Device Company with DDR LVDS or CMOS outputs and single-channel AD9957 DUC of Analog Device Company with CMOS inputs. Because of containing a FMC-HPC connector, FMC-NKS-401110 is mechanically and electrically compliant to VITA 57.1 standard. Controlling of clock source, sampling frequency and calibration by a SPI BUS are its other features. The clock sampling can be provided from an external or internal source and then send to distribution clock unit. Additionally, a trigger input for customized sampling control is available. This module can use on every carrier card which follows the VITA 57.1 standard; therefore it can have the maximum data throughput and minimum latency.

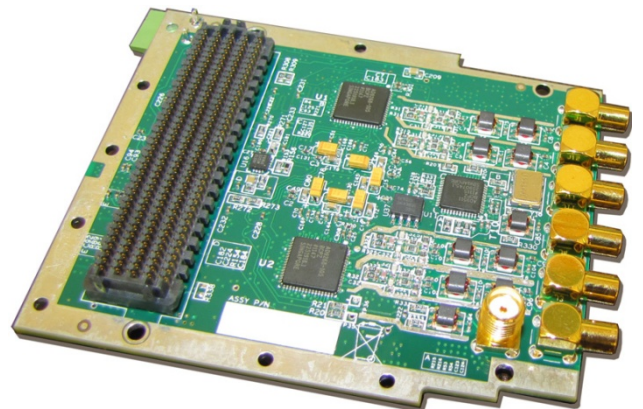

Functional Block Diagram

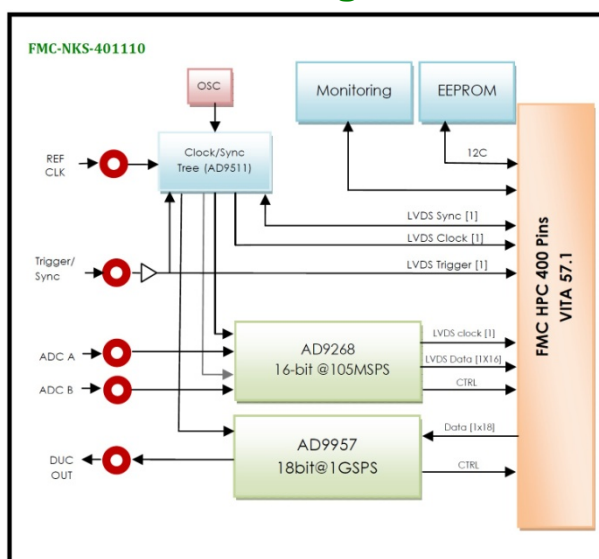

Application

- RADAR/SONAR
- Advanced automatic pilot systems (Auto Pilot)
- Diversity radio systems
- Multimode digital receivers (3G)
- GSM, EDGE, W-CDMA, LTE

WWW.NIKSOO.COM/FMC-NKS-401110

Support: support@niksoo.com www.niksoo.com
Email: info@niksoo.com

Features

ADC's:

- 2 Channels, 16-bit Resolution, 105 MSPS
- Differential Analog Input with 650MHz Bandwidth
- Analog Input Filter Options
- SNR = 75 dBFS @ 70 MHz and 105 MSPS
- SFDR = 86 dBc @ 70 MHz and 105 MSPS
- ENOB = 12.5 Bits @ 70 MHz and 105 MSPS
- Xtalk Isolation > 95dB
- Low Power: 750 mW @ 105 MSPS
- High Performance AC-Coupled Analog Input
- Flexible Analog Input Range: 1V p-p to 2V p-p
- Serial Port Control
- Pin Compatible with AD9258, AD9251, AD9231 and AD9204.

DUC's:

- 1 GSPS Internal Clock speed (up to 400 MHz Analog Output)
- Phase Noise ≤ -125 dBc/Hz (400 MHz Carrier @ 1 kHz Offset)
- Excellent Dynamic Performance >80 dB Narrow-Band SFDR
- 8 Programmable Profiles for Shift Keying
- Sin(x)/(x) Correction (Inverse Sinc Filter)
- Internal Oscillator for a Single Crystal Operation
- Interpolation Factors From 4 \times to 252 \times
- Interpolation DAC Mode
- Internal Divider Allows References up to 2 GHz
- 1.8 V and 3.3 V Power Supplies

Other's:

- VITA 57.1 Compliant
- FMC Interface Connector for Digital Output, Power LEDs and Single-ended MCX Connector for AIN, AOUT & EXTCLK
- Flexible clock tree enables
- Direct ADC Connection to Host FPGA Ensures
- Operating temperature: -40°C to +85°C (Industrial)
- Physical Dimensions (L: 83.8 mm, W: 69 mm)

Board Features

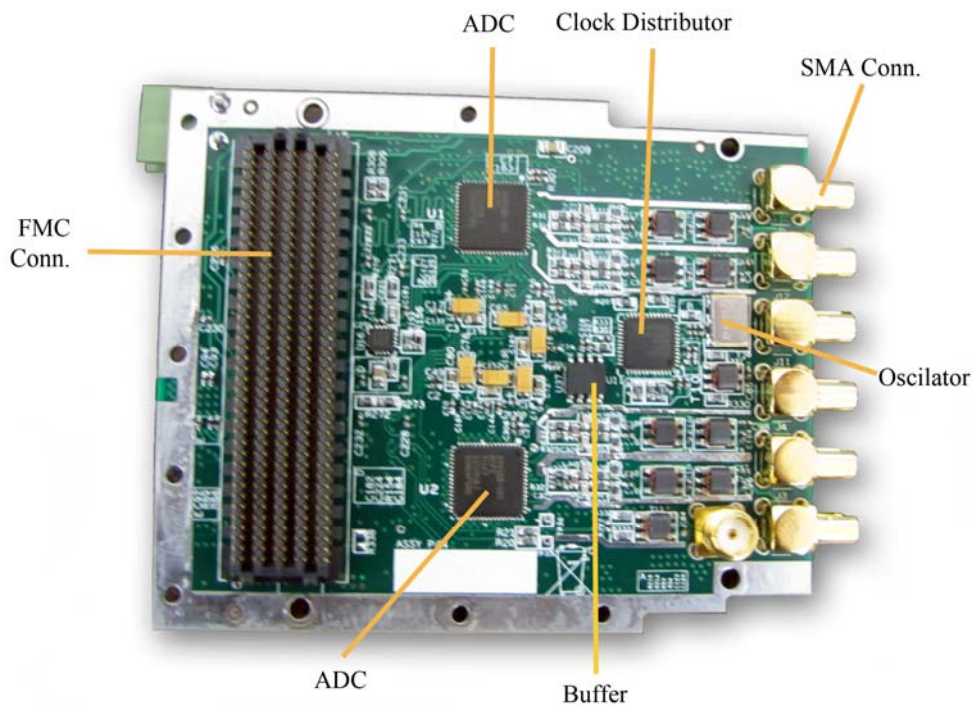
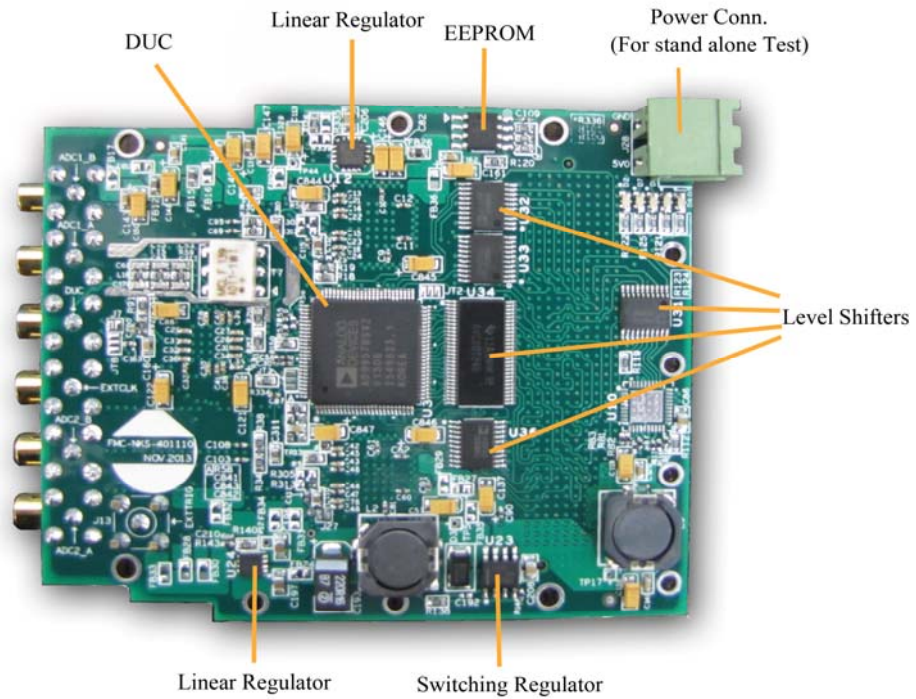

Compatibility Table

Platform	Compatibility
FMC-NKS016-PCIE-A	Yes
FMC-NKS106-PCI-A	Yes
FMC-NKS-V106-A	Yes
VITA57.1 Carrier Cards	Yes

Order Information

