

FMC-NKS016-PCIe-B High/Low Pin Count FMC Virtex-6 Processing PCIe Card

Description

The FMC-NKS016-PCIe-B board is a high performance FMC industrial carrier card based on the Xilinx Virtex-6 LX240T FPGA family and plugged into a serial PCIe bus system unit supporting 1x, 4x and 8x PCIe data paths and Ethernet 10/100/1000. This board also provides a developed platform for designing and verifying Virtex-6 FPGA based PCIe and stand-alone applications. Communication with a host computer via the PCIe bus and other interfaces enables users to control the card, modify algorithm settings and process real-time signals. The on-board FPGA Mezzanine Connectors (FMC) can make a high bandwidth data transfer channel with VITA 57.1 standard modules.

Features

- Virtex XC6VLX240T-2FFG1156C Xilinx Device
- PCI Express x8 Edge Connector
- FMC HPC for FMC Modules Connect to FPGA
- FMC LPC for FMC Modules Connect to FPGA
- 4 Gb DDR3 Component Memory
- Ethernet PHY 10/100/1000 Interface with RJ-45 Connector
- 2x RS485 and 2x RS232 Interface Connect to FPGA
- USB JTAG Through Digilent Module
- USB 3.0
- User Push-button, Switches, LEDs
- Multi-boot Configuration
- Power on/off Slide Switch
- 12V PCIe HDD Connector or External Voltage Supply
- Physical Dimensions (L: 236 mm, W: 127mm)
- Industrial Temperature Range (0°C to 85°C)
- Operation System Support: Windows & Linux

Functional Block Diagram

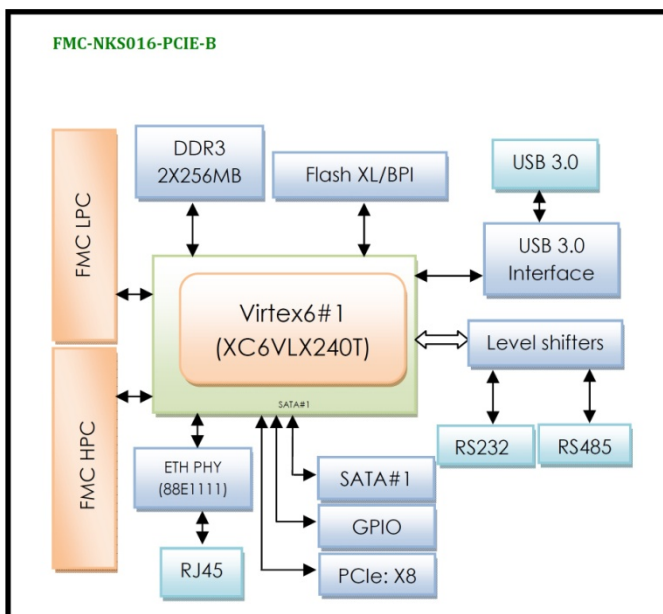

Application

- RADAR/SONAR
- Communications
- Multimode Digital Receivers
- Ultrasound Equipment
- Broadband data Applications

Compatibility Table

NIKSOO Platform	Compatibility
FMC-NKS-210000	Yes
FMC-NKS-210210	Yes
FMC-NKS-401210	Yes
FMC-NKS-401000	Yes
FMC-NKS-000210	Yes
FMC-NKS-110110	Yes
FMC-NKS-601000	Yes
FMC-NKS-401110	Yes

Order Information

