

FP-NKS-01-A High Pin Count QSH Carrier Virtex-4 Processing PCI Card

Description

The FP-NKS-01-A is a QSH industrial carrier card based on the Xilinx Virtex-4 LX40 FPGA family and supports 32-bit or 64-bit PCI bus data paths, Ethernet10/100 and USB 2.0. This board also provides a developed platform for designing and verifying Virtex-4 FPGA based PCI and Stand-Alone applications. It is optimized version to operate at higher frequencies (500 Hz<). Communication with a host computer via the PCI bus and other interfaces enables users to control the card, modify algorithm settings and process real-time signals. Additionally, this card can transfer high bandwidth data through QSH/QTH standard modules.

Features

- Virtex XC4VLX40-11FFG1148C Xilinx Device
- 64-bit 66MHz/32-bit 33MHz PCI Add-in Card Connector
- Enhanced 10/100 Ethernet Full Stack Interface with RJ-45 Connector
- QSH Connector for ADC/DAC QTH Modules Connect to FPGA
- Spartan XC3S50AN for PCI-based and User I/O
- Device Configuration Through On-board Platform Flash (32Mb), or Download Using Xilinx Platform Cable USB (JTAG Programming Interface)
- 1 Gb SDRAM Component Memory (up to 167MHZ)
- User Push-button, Switches, LEDs and GPIO Header
- JTAG and Trace Debug Ports (ChipScope Support)
- Enhanced High Speed USB 2.0 Interface
- PCI Clocking Support for Global and Regional Clocking Applications
- Four On-board Clock Sources
- SPI EEPROM (4Mb)
- 5.0V PCI & External Voltage Supply
- Physical Dimensions (L: 236.7 mm, W: 120.1 mm)
- Industrial Temperature Range (0°C to 85°C)
- Operation System Support: Windows & Linux

Functional Block Diagram

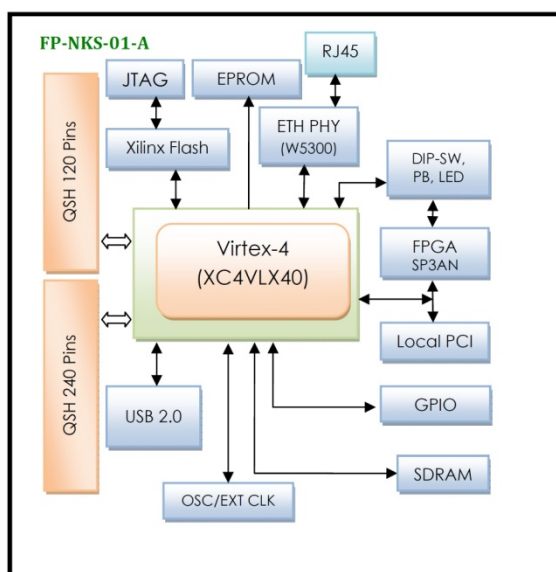

Application

- RADAR
- High Bandwidth Data Transfer
- Parallel Processing Application
- Communications
- Complex DSP Applications
- Fire Control and Defense Systems

WWW.NIKSOO.COM/FP-NKS-01-A

Support: support@niksoo.com
Email: info@niksoo.com

www.niksoo.com

Board Features

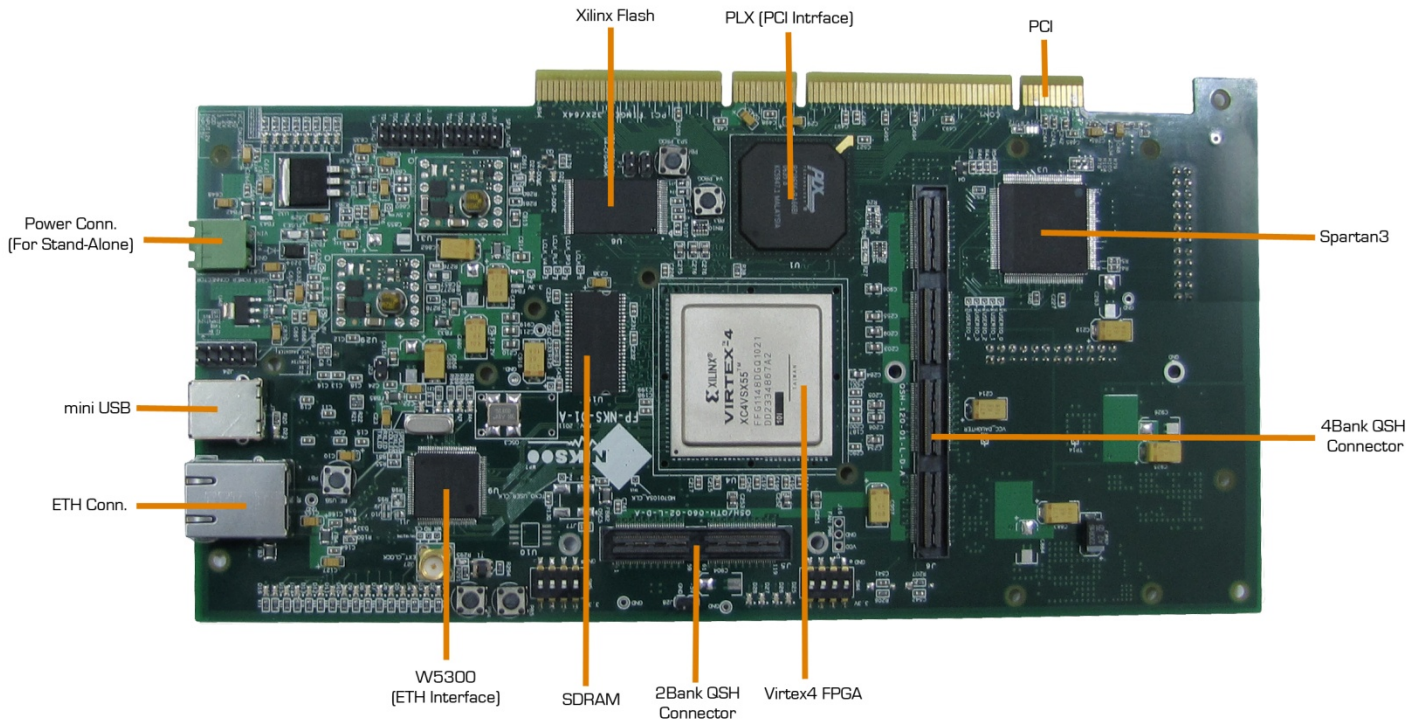

Compatibility Table

NIKSOO Platform	Compatibility
QTH-NKS-01	Yes
QTH-NKS-02	Yes
QTH-NKS-02-A	Yes
QTH-NKS-03	Yes
QTH-NKS-07	Yes
QTH-NKS-10	Yes
QTH-NKS-11	Yes
QTH-NKS-12	Yes
QTH-NKS-11-A	Yes



FP-NKS-01-A
