

NKS-V016-A Stand-Alone Board

Virtex-6 & DSP High Performance Processing Platform

8- Channel 16-bit ADC 125MSPS

4- Channel 16-bit DAC 1GSPS

Description

The NKS-V016-A processing board is a high performance industrial single card dedicated to high performance data acquisition and communications based on the Xilinx Virtex-6 LX550T FPGA family. The NKS-V016-A board enables designers to prototype high-performance digital transceivers. The board includes a DSP Processor (TMS320C6678) which incorporating the new and innovative C66x DSP core, this device can run at a core speed of up to 1.25 GHz. Additionally four D/A channels 16 bit resolution at maximum rate of 1GSPS per channel and eight A/D channels 16 bit resolution at maximum rate of 125 MSPS per channel are available. The sample clock can be supplied from PLL clock distributor, externally through a coax connection or supplied by an internal clock source.



Application

- RADAR/SONAR
- Communications
- Diversity radio systems
- Multimode digital receivers (3G)
- GSM, EDGE, W-CDMA, LTE
- General-purpose software radios
- Broadband data applications
- I/Q demodulation systems
- Fire Control and Defense Systems
- Smart antenna systems

Functional Block Diagram

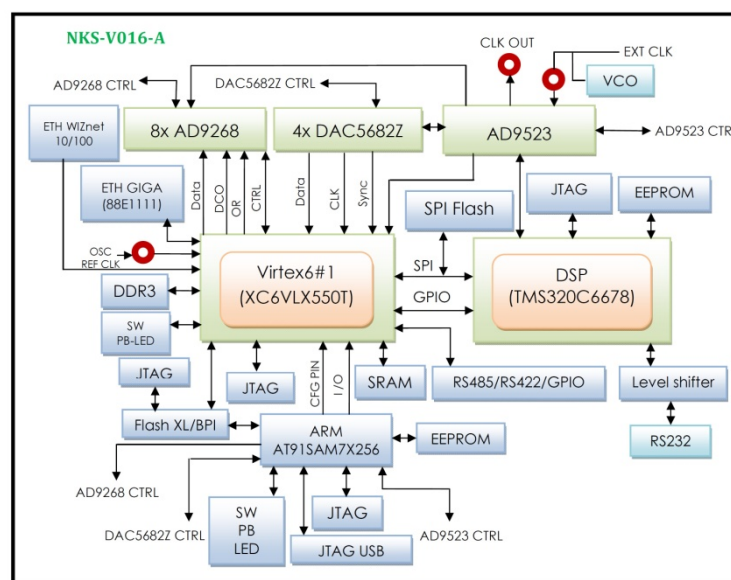

Features

ADC's:

- 8 Channels, 16 bit, 125MSPS
- Differential Analog Input with 650MHz Bandwidth
- Analog Input Filter Options
- SNR = 75 dBFS @ 20 MHz and 125 MSPS
- SFDR > 80 dBc @ 20 MHz and 125 MSPS
- ENOB = 12.4 Bits @ 20 MHz and 125 MSPS
- Xtalk Isolation > 95dB
- Low Power: 750 mW @ 125 MSPS
- High Performance AC-Coupled Analog Input With 8 Channel AC/DC Coupled Switching Capability
- 1.8 V Analog Supply Operation
- 1.8 V CMOS or LVDS Output Supply
- Flexible Analog Input Range: 1V p-p to 2V p-p
- Pin Compatible with AD9258, AD9251, AD9231 and AD9204

DAC's:

- 4 Channels, 16-Bit, 1GSPS Update Rate
- Analog Output with 500MHz Bandwidth
- Analog Output Filter Options
- Phase Noise > 100dBc @ 1kHz and 1GSPS
- Interleaved I/Q data for Dual-DAC Mode
- 2x-32x Clock Multiplying PLL/VCO
- 2x or 4x Interpolation Filters
- High Performance AC-Coupled Analog Output with 2 Channel AC/DC Coupled Switching Capability
- Pin Compatible with DAC5681

Other's:

- Virtex XC6VLX550T-1FFG1759C Xilinx Device
- Digital Signal Processing (DSP) TMS320C6678 TI Device
- ARM Microcontroller AT91SAM7X256 Atmel Device
- 4 Gb DDR3 Component Memory (Two [256 Mb x 8] Devices)
- 144 Mb @ 167MHz SRAM Component Memory (Two [4Mb x 18] Devices)
- Flexible PLL Clock Tree Enables (Internal Clock, External Clock, Internal Clock with External Reference)
- Ethernet PHY 10/100/1000 Interface with RJ-45 Connector for FPGA
- Ethernet WIZnet 10/100 Interface with RJ-45 Connector for FPGA
- Multi-boot Configuration
- 20x RS422, 5x RS485, 24x GPIO and 1x CAN BUS Serial Interfaces
- Status and Debug LEDs
- Power on/off Slide Switch
- Physical Dimensions (L: 249.9 mm, W: 233.2 mm)
- Operating temperature: 0°C to +85°C (Industrial)
- 12V External Voltage Supply
- Operation System Support: Windows & Linux

Board Features

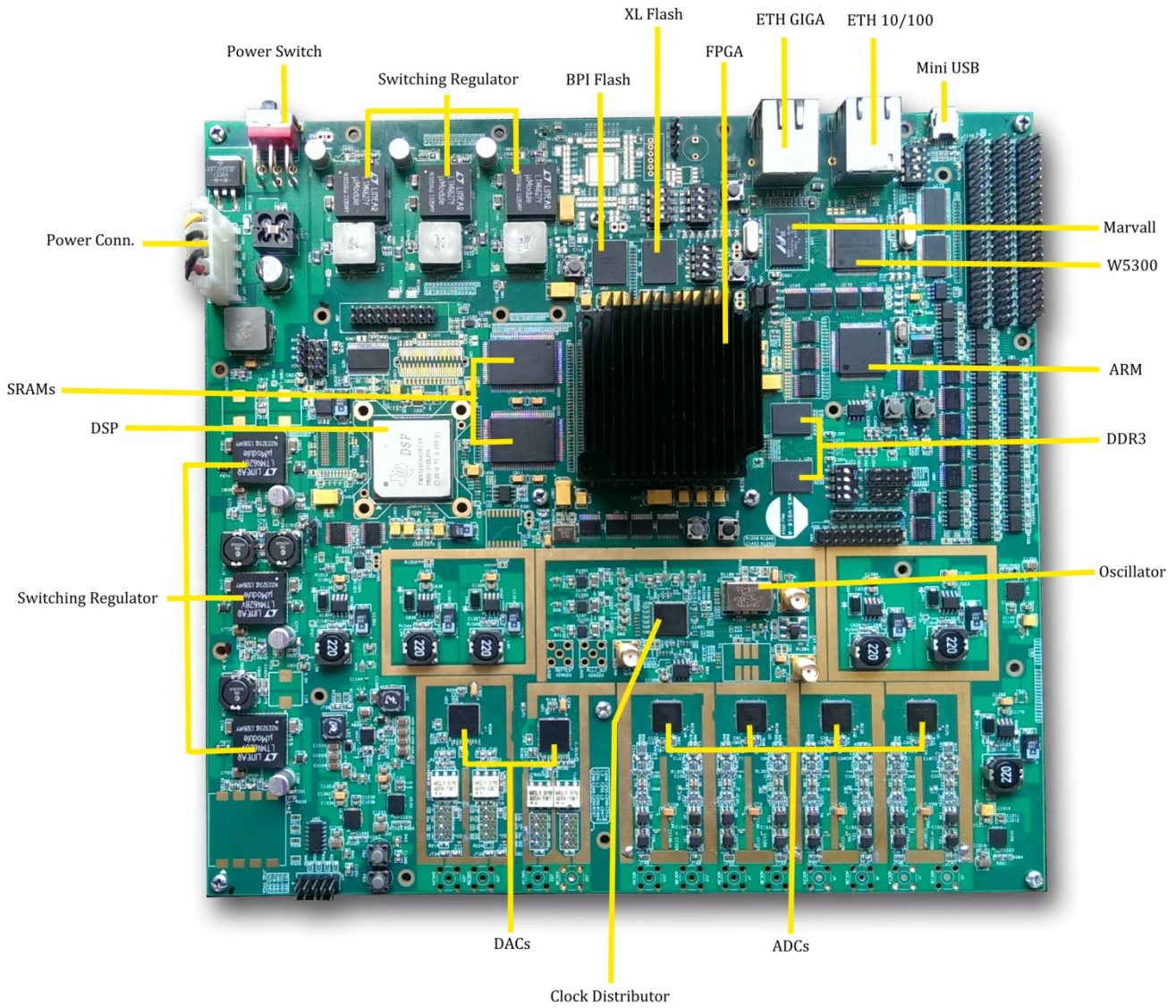

Order Information

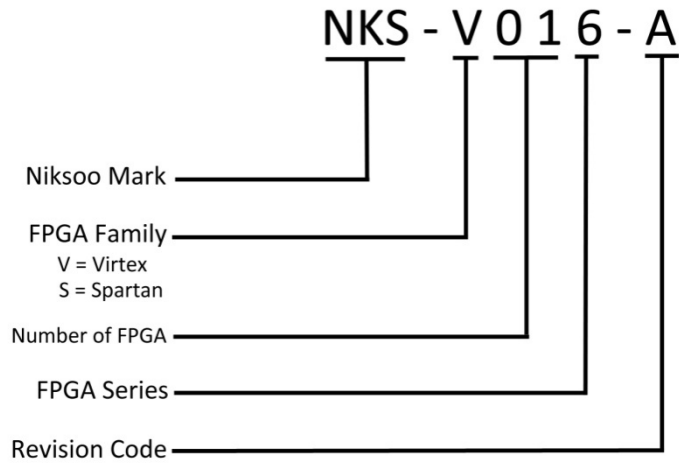



NKS-V016-A
