

QTH-NKS-07 High Pin Count QTH Module 4- Channel 14-bit ADC 80MSPS

Description

The QTH-NKS-07 is an 4-channel 14-bit ADC at 80MSPS that enable simultaneous and high speed sensitivity. This module was designed based on two-channel ADS62P43 ADC of TI Company with CMOS and DDR LVDS outputs. The clock sampling can be provided from an external or internal source and then send to distribution clock unit. This module can use on every carrier card which follows the QSH/QTH standard; therefore it can have the maximum data throughput and minimum latency.

Features

- 4 Channels, 14-bit Resolution, 80MSPS
- SNR = 73 dBFS @ 70 MHz and 80 MSPS
- SFDR = 86 dBc @ 70 MHz and 80 MSPS
- ENOB = 11.6 Bits @ 70 MHz and 80 MSPS
- Analog Input Filter Options
- Efficient Parallel CMOS & DDR LVDS-Compatible Outputs
- Flexible Analog Input: 2V p-p Range
- Serial Port Control: Programmable Clock and Data Alignment
- 3.3V Analog Supply Operation
- Xtalk Isolation >91 dB
- High Performance DC-Coupled Analog Input
- On-board a Clock Distributer
- Differential Input with 450 MHz Bandwidth
- On-board 125 MHz Ultra Low Phase Noise Crystal Oscillator
- QTH Interface Connector for Digital Output, Power LEDs and Single-ended MCX Connector for AIN & EXTCLK
- Direct ADC Connection to Host FPGA Ensures Maximum Throughput
- Physical Dimensions (L: 107.7 mm, W: 92.2 mm)
- Pin Compatible to ADS62P2X Family
- Industrial Temperature Range (-40°C to 85°C)

Functional Block Diagram

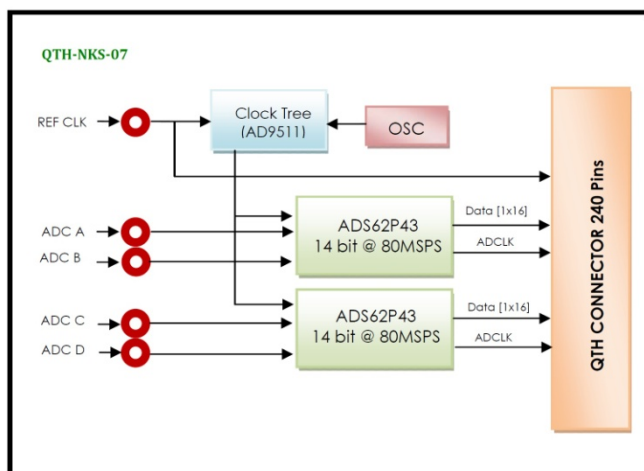

Application

- RADAR/SONAR
- Medical Imaging
- Data Acquisition
- Wireless communications infrastructure equipments
- Test Measurement Instrumentation

Board Features

SMA Connector

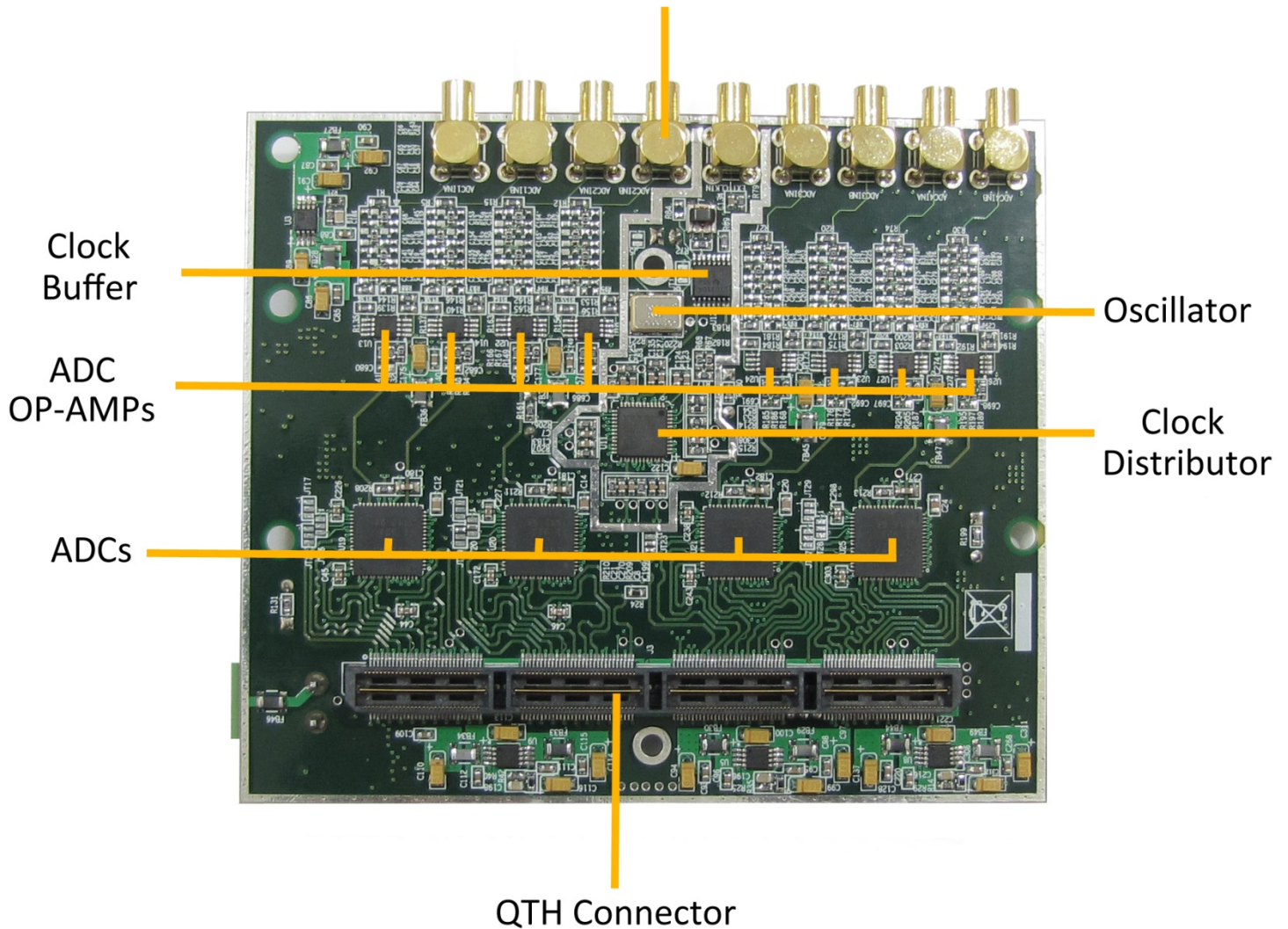

Oscillator

Clock Distributor

QTH Connector

Compatibility Table

NIKSOO Platform	Compatibility
NKS-V5-PCIE-A-SX50T	Yes
NKS-V5-PCIE-A-SX95T	Yes
FP-NKS-01-A	Yes
NKS-V5-PCI-A	Yes
FMC-NKS106-PCI-A	Yes
FMC-NKS016-PCIE-A	Yes

Order Information

