

INTELART

IM220 V1.0

Digital output Module

User Manual

www.intelart.ir

08/2021

Warning notice system

This manual contains notices you have to observe in order to ensure your personal safety, as well as to prevent damage to property. The notices referring to your personal safety are highlighted in the manual by a safety alert symbol, notices referring only to property damage have no safety alert symbol. These notices shown below are graded according to the degree of danger.

DANGER

indicates that death or severe personal injury will result if proper precautions are not taken.

WARNING

indicates that death or severe personal injury may result if proper precautions are not taken.

NOTICE

indicates that property damage can result if proper precautions are not taken.

Qualified personnel

The product/system described in this documentation may be operated only by personnel qualified for the specific task in accordance with the relevant documentation, in particular its warning notices and safety instructions.

Qualified personnel are those who, based on their training and experience, are capable of identifying risks and avoiding potential hazards when working with these products/systems

Contents

- 1 Technical Specifications 1
 - 1.1 Hardware Parameters 1
- 2 Configurations..... 2
 - 2.1 Digital Inputs **Error! Bookmark not defined.**
 - 2.2 Digital Outputs 2
 - 2.2.1 Pulse width modulation (PWM)..... 2
 - 2.2.2 Pulse train 4
 - 2.2.3 Stop action 4
- 3 Address Space 5
- 4 Diagnostic and Wiring..... 7
- 5 Dimensional drawing 9

1 Technical Specifications

1.1 Hardware Parameters

The following table specifies the hardware information of the module.

Table 1 Hardware parameters

Digital Outputs	Outputs count	16
	Type of digital output	Isolated transistor (sinking)
	Type of output voltage	DC
	Operating voltage	5 to 30 V
	Rated operating voltage	24V
	Rated max current	0.3A
	Delay time from "1" to "0"	20 μ s
	Delay time from "0" to "1"	30 μ s
	Stop action support	Yes. Shut Down, Keep Last Value, Output 1, Output Custom Value
	PWM output:	Yes
	<ul style="list-style-type: none"> • Frequency range • Min pulse duration 	0.5 to 1000 Hz (duty cycle 5% ~ 95%) 100 μ s
	Pulse train output:	Yes
<ul style="list-style-type: none"> • Pulse period range • Pulse count range 	0.2 to 13107 ms 1 to 65535	
Dimensions	Width	30mm
	Height	102mm
	Depth	58mm
Ambient Conditions	Storage temperature	-15 to 75 °C
	Operating temperature	0 to 55 °C
Miscellaneous	Weight	Approx. 90g
	Power LED	Yes. Green LED
	Diagnostic LED	Yes. Yellow LED

2 Configurations

2.1 Digital Outputs

The outputs of the module can configure in order to execute another function.

2.1.1 Pulse width modulation (PWM)

The output channels are grouped in 4 clusters. Each group has its own PWM frequency setting in the properties window of the module. All groups PWM frequency vary from 0.5Hz to 1000Hz.

Table 2 PWM Grouped digital outputs

Group 0	Group 1	Group 2	Group 3
DQ00	DQ02	DQ04	DQ07
DQ01	DQ03	DQ05	

When any alternate function of a group sets as PWM, a new property will be appeared in order to set the PWM frequency of that group.

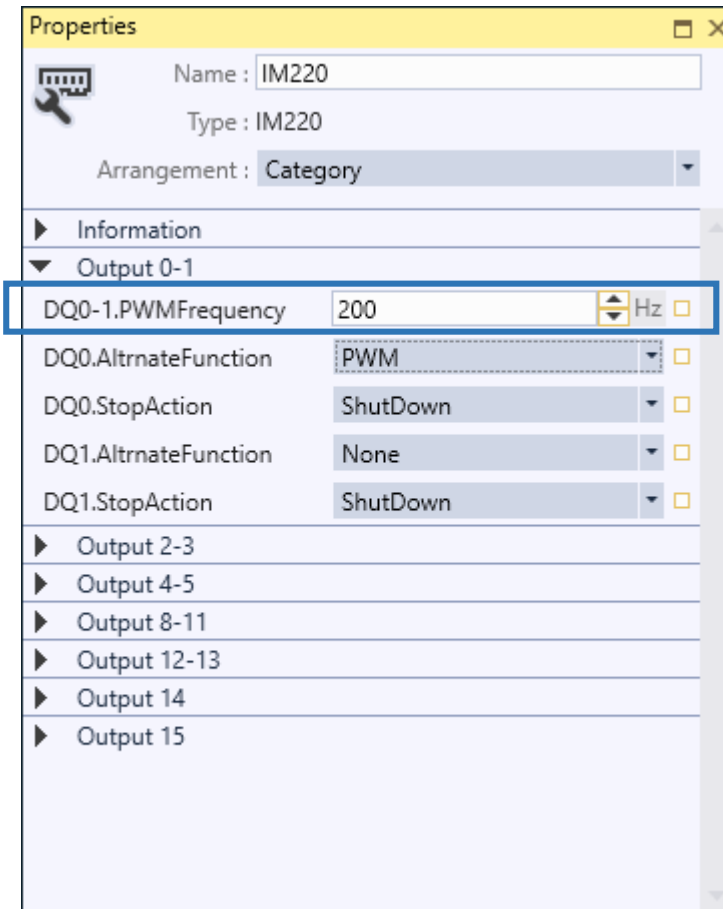

Figure 1 PWM frequency setting

The pulse waveform is slightly wider than the ideal pulse waveform for a resistive load. The following figure shows the ideal PWM signal versus the actual signal waveform. The ideal signal is specified by the blue line and the actual waveform is figured by the dashed line. The duty cycle can vary from 0% to 100%. The minimum pulse duration is 100 μ s. For example, if you set the frequency of output PWM to 1000Hz (a period of 1000 μ s) and a duty cycle of 5%, this results a pulse duration of 50 μ s but the actual pulse duration will be 100 μ s.

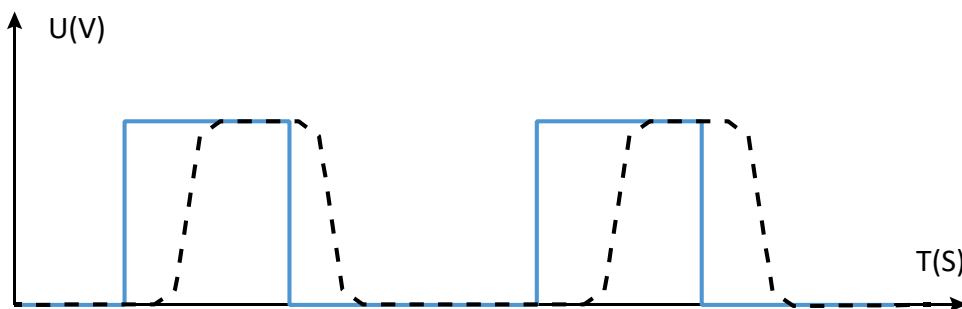

Figure 2 Actual PWM waveform of a resistive load

2.1.2 Pulse train

The pulse train function generates a configurable PWM signal with duty cycle of 50% and specified pulse count. The period of the PWM signal is a factor of 200µs.

2.1.3 Stop action

Each output channel has a property named “StopAction” which determines the act of channel when PLC state changes to stop mode. Some options will be unreachable depending on the selected alternate function of the channel.

Table 3 Available stop actions

Alternate Function	Available Stop Actions
None	ShutDown, KeepLastValue, Output 1
Pulse Train	
PWM	ShutDown, KeepLastValue, OutputCustomValue

3 Address Space

The value of input channels and output channels and some configurations will be accessible via an address space. There are bunch of predefined mapped tags in order to read or write a value in the address space. The following table illustrates the type and purpose of each mapped tag.

Table 4 Mapped tags of parameters in the address space







Category	Name	Data Type	Address	Function
Input Space (I)				
Pulse Train	PulseReadyI00	BOOL	%I68.0	Indicates accomplishment of pulse generating when the alternate function is set to "PulseTrain"
	⋮		⋮	
	PulseReadyI07		%I68.7	
Diagnose	DiagInfo	WORD	%IW72	Gets all diagnostic information when the module is in RUN mode.
				<ul style="list-style-type: none"> • Bit 0: DQ power missing • Bit1- Bit15: Reserved
Output Space (Q)				
Digital Outputs	DQ00	BOOL	%Q0.0	Sets or gets the value of channel when its alternative function is set to "None"
	⋮		⋮	
	DQ07		%Q0.7	
	DQ00_07	BYTE	%QB0	A wrapper to get first 8 digital output channel values as a byte
	DQ08	BOOL	%Q1.0	Sets or gets the value of channel when its alternative function is set to "None"
⋮	⋮			
DQ15		%Q1.7		
	DQ08_15	BYTE	%QB1	A wrapper to get second 8 digital output channel values as a byte
	DQ00_15	WORD	%QW0	A wrapper to get all digital output channel values as a byte

Pulse Train	PulseStartQ00 : PulseStartQ07	BOOL	%Q8.0 : %Q8.7	Starts the pulse generating process
	PulsePeriod00	UINT	%QW4	Sets or gets the value of pulse period. Note that the value is a factor of 200µs. Example: if you set the value to 5 then the pulse period of the output will be 5*200 µs=1000 µs
	PulsePeriod01		%QW12	
	PulsePeriod02		%QW20	
	PulsePeriod03		%QW28	
	PulsePeriod04		%QW36	
	PulsePeriod05		%QW44	
	PulsePeriod06		%QW52	
	PulsePeriod07		%QW60	
	PulseCount00	UINT	%QW6	Sets or gets the value of pulse count.
	PulseCount01		%QW14	
	PulseCount02		%QW22	
	PulseCount03		%QW30	
	PulseCount04		%QW38	
	PulseCount05		%QW46	
	PulseCount06		%QW54	
	PulseCount07		%QW62	
	PWM	PwmDuty00	USINT	%QB4
PwmDuty01		%QB12		
PwmDuty02		%QB20		
PwmDuty03		%QB28		
PwmDuty04		%QB36		
PwmDuty05		%QB44		
PwmDuty06		%QB52		
PwmDuty07		%QB60		

4 Diagnostic and Wiring

The module has 2 LEDs indicating the status of module. The following table explains the combination of these two LEDs state.

Table 5 Combination of "POWER" and "MAINT" LEDs

LED		Indicating	Solution
POWER	MAINT		
 Off	 Off	Power missing or hardware failure.	<ul style="list-style-type: none"> • Check the main power supply • Verify that the module is installed correctly
 On	 On	The module is configured and is in RUN mode.	--
 On	 Flashes	Indicates an error (communication error, configuration error etc.)	<ul style="list-style-type: none"> • Verify that the module is installed correctly

The following block diagram shows you information about wiring of the module.

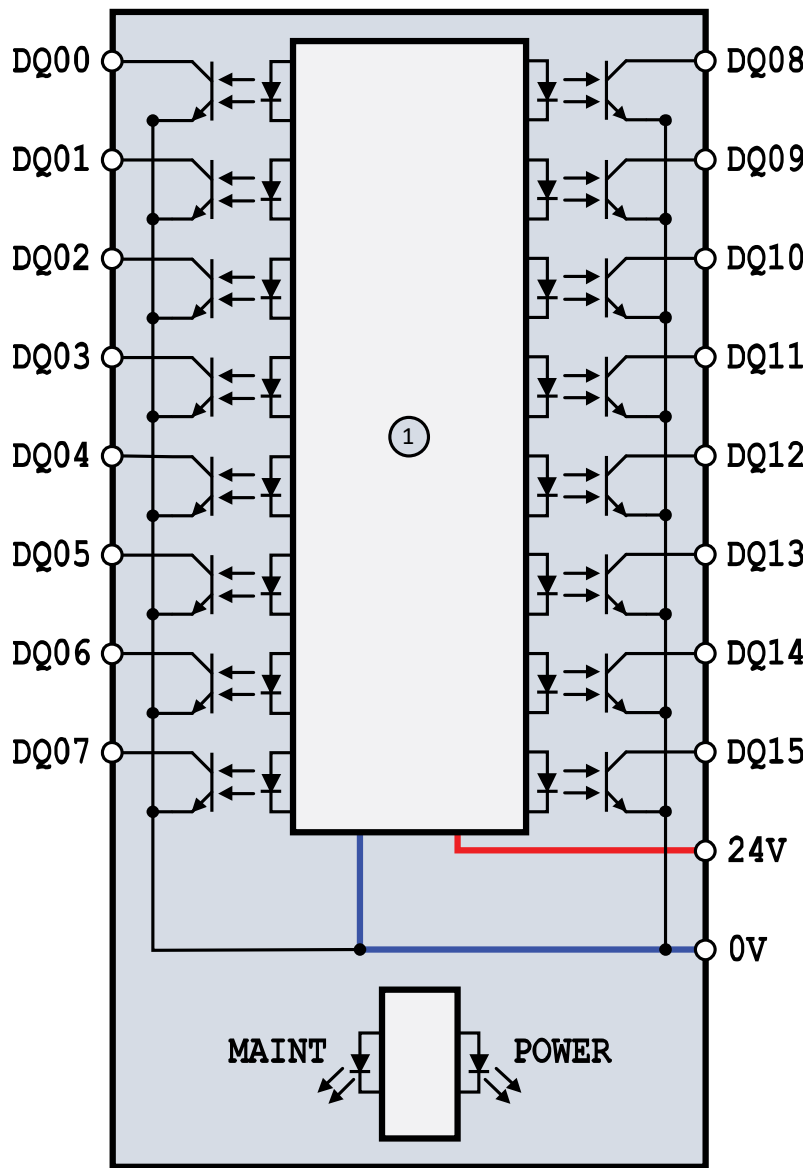

Figure 3 Wiring diagram and terminal assignments

- | | | | |
|---------------|-----------------|---------------|-------------------------|
| 1 | Digital outputs | DQx: | Digital output terminal |
| POWER: | Power LED | MAINT: | Maintenance LED |

5 Dimensional drawing

The dimensions of the module are available in this section. For install the module and its main device follow the below dimensional drawing.

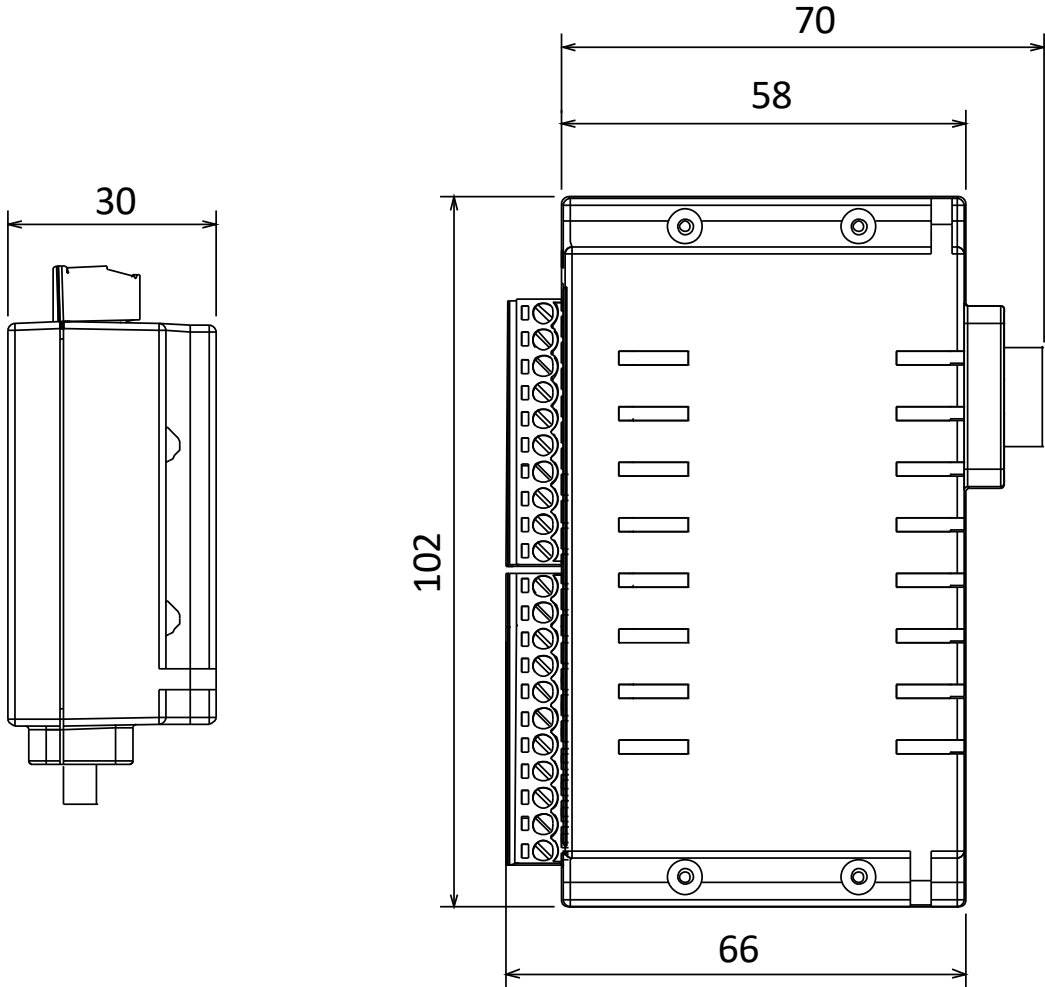

Figure 4 Dimensional drawing of IM220 module